

REFERENCE
2D FLOOR
DEC 13 '32

electronics

radio, sound, communications and industrial applications
of electron tubes + + + design, engineering, manufacture

Government's
suit settled

Directional
broadcasting

Photo-electric
effects in
amplifier tubes

Novel acoustic
features of
WCAU's new
studios

Reducing
electrical
interference

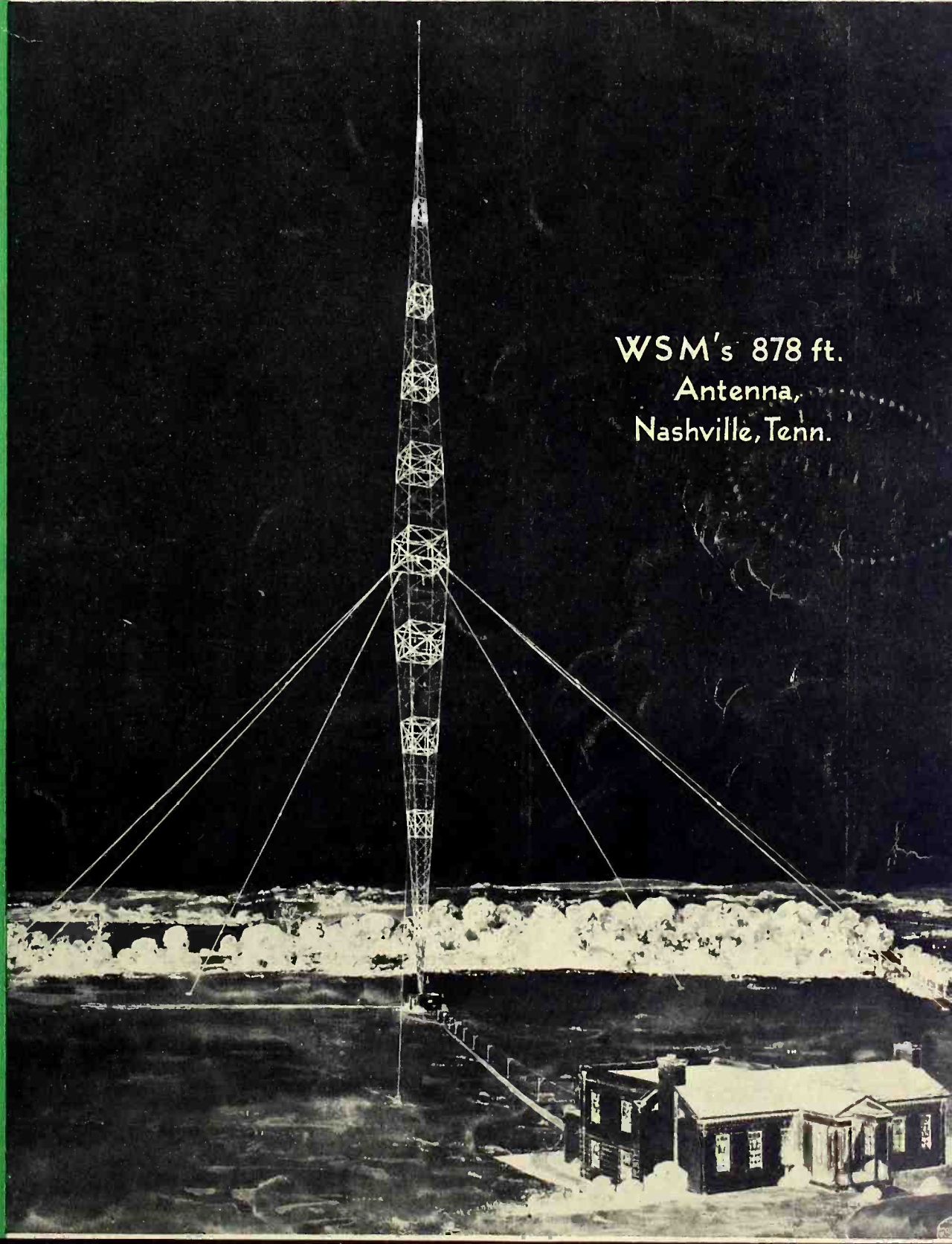

WSM's 878 ft.
Antenna,
Nashville, Tenn.



McGRAW-HILL PUBLISHING COMPANY, INC.

Price 35 Cents

DECEMBER 1932

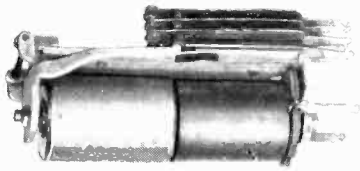

Typical Strowger slow-acting relay (2/5 actual size)

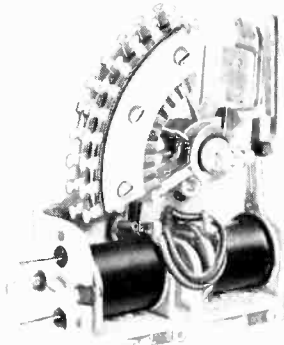

10-point single-motion selecting switch (1/3 actual size)

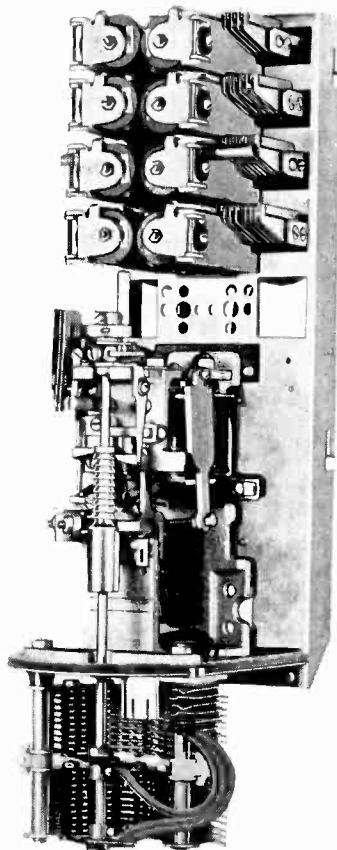

100-point two-motion selecting switch (2/9 actual size)

In these Strowger Products are Solutions to Your "Remote-Control" Problems



For more than 40 years Strowger relays, selecting switches and other electrical apparatus have been applied to a wide variety of uses. Each year sees them entering new fields, meeting new needs.

Strowger Products are operating the telephones in great metropolitan networks, guiding airplane flights, controlling city street traffic, turning on and off lights in electric signs—performing hundreds of other functions.

During four decades Strowger Products have been tried, tested and refined until today they stand pre-eminent. Sturdy, flexible, reliable—their excellence of material and finished workmanship insure long life and permanence of adjustment.

Their low unit cost, combined with uniformly high quality, make them truly economical.

If you have a problem of electrical control, whether it spans a thousand miles or involves millimeters, our Sales Engineering Division is the link between your need and our ability to serve. We invite you to a consultation. Wire or write to American Automatic Electric Sales Company, 1033 W. Van Buren Street, Chicago.

Strowger Products are made by

AUTOMATIC ELECTRIC COMPANY

SALES AND SERVICE OFFICES

NEW YORK · PHILADELPHIA · BOSTON · PITTSBURGH · WASHINGTON, D. C. · CLEVELAND
CINCINNATI · ATLANTA · DETROIT · ST. PAUL · KANSAS CITY, MO. · LOS ANGELES

Through our affiliated factories in England and Belgium we can serve your foreign plants with identical equipment economically and promptly

electronics

O. H. CALDWELL
Editor

KEITH HENNEY
Associate Editor

McGRAW-HILL PUBLISHING COMPANY, INC.

New York, December, 1932

How electronic industries will benefit from

The RCA settlement

"The Radio Corporation of America receives additional patent rights under licenses from the General Electric and Westinghouse companies which will enable it to extend its manufacturing business *into new phases of the electronic art*. These additional rights will enable RCA to direct its business in a natural and normal manner toward an enlarged field through the application of radio tubes and their circuits to *other uses than radio*."

DAVID SARNOFF,
President Radio Corporation of America

SIGNIFICANT to all interested in the electronic field is the above official announcement of the entry of another industrial giant into the wider application of electronics, growing out of the consent decree and settlement of the Government's suit against the RCA. Amid all the turmoil of readjustment of a complex legal situation again there is given recognition of the expanding importance of the non-radio applications of the tube and amplifier.

Already it is well known that no less than 85 per cent of the entire vast research laboratory of the General Electric Company is devoted to study of electronic processes. And roughly the same proportion applies to the laboratories of the Westinghouse companies. If RCA is to be separated completely from its parent companies and their manifest destiny in the electronic fields, then it was logical that the disinherited offspring be granted authority to proceed energetically along its own paths of non-radio, electronic expansion, — a field to which it has already made many important contributions.

Under the settlement the Radio Corporation obtains rights to manufacture radio transmitters, and continues its own activities in the fields of receiving sets, tubes, musical instruments, television, communication broadcasting and sound pictures. General Electric and Westinghouse may also enter the radio field after 30 months. Licenses in future may be obtained either from the RCA, or from the individual patent owners.

THUS the consent decree can be hailed as ushering in a new day for both radio and the electronic arts. Under its terms uncertainty has been ended, and succeeded by a settled program. Executives and engineers on all sides, freed of legal burdens, can now devote themselves to business development in both radio and its allied domain of electronics.

New impetus is given to the whole industry, and from the new set-up independents, as well as erstwhile "trust" interests, will all benefit.

radio
sound
pictures
telephony
broadcasting
telegraphy
counting
grading
carrier
systems
beam
transmission
photo
cells
facsimile
electric
recording
amplifiers
phonographs
measurements
receivers
therapeutics
traffic
control
musical
instruments
machine
control
television
metering
analysis
aviation
metallurgy
beacons
compasses
automatic
processing
crime
detection
geophysics

ACOUSTIC FEATURES OF

"Live and dead-end" construction. Sound-proofing of floating walls, floors and ceilings

DURING this month there will be put into operation at Philadelphia, the new studios of Station WCAU, located at 1622 Chestnut Street, one of the first buildings to be erected especially for broadcasting purposes, and designed to feature a number of novel acoustic characteristics. The WCAU installation is also of particular interest as being the first large studios in the United States to be designed with "live" and "dead ends." From one-half to two-thirds of each room, depending on the size of the studio, is lined with sound-absorbing material to form a "dead end" where the microphones will be placed to receive every note and part of the program which will be in progress at the opposite or "live end" of the room. The "live end" walls are finished with a hard material that reflects the sound waves to the receiving, or "dead," end.

Another innovation that has never been used in this country are the zigzagging walls of the two larger studios. These studios are constructed with zig-zag panels which break up the sound as it strikes the sides and deflect the sound waves at various angles, providing a smoother distribution of sound and freedom from interference.

Another feature of interest to acoustic engineers is the private laboratory and workshop which has been provided in the new WCAU building for Dr. Leopold Stokowski, director of the Philadelphia Orchestra.

Dr. Stokowski has long shown great personal interest and resourcefulness in methods of improving musical transmission over wire and radio circuits, and here he will have a private laboratory where he can experiment and construct new electronic musical instruments, try out various microphone constructions, and develop new arrangements of circuits for improved reproduction, preliminary to putting them on the air.

With its new 50-kw. transmitter recently completed at Newtown Square, Pa., Station WCAU becomes one of the high-power links in the Columbia Broadcasting System, and with the key studios at New York becoming overloaded, it is planned to transfer the origination of a number of CBS net work programs to the new WCAU studios described in this article.

The studio building itself is of striking appearance, blue in color. It is surmounted by a 100-ft. tower of glass, stainless steel and bronze. Behind this glass will glow banks of the new General Electric low-voltage mercury-vapor lamps, making the tower a brilliant landmark in the night sky, visible for miles around Philadelphia.

Occupying the four upper floors of the WCAU Building, these studios, which include the eight principal broadcasting rooms—Studios A, B, C, D, F, G, H and J—as well as a number of audition and rehearsal rooms, recording rooms and special studios have been designed

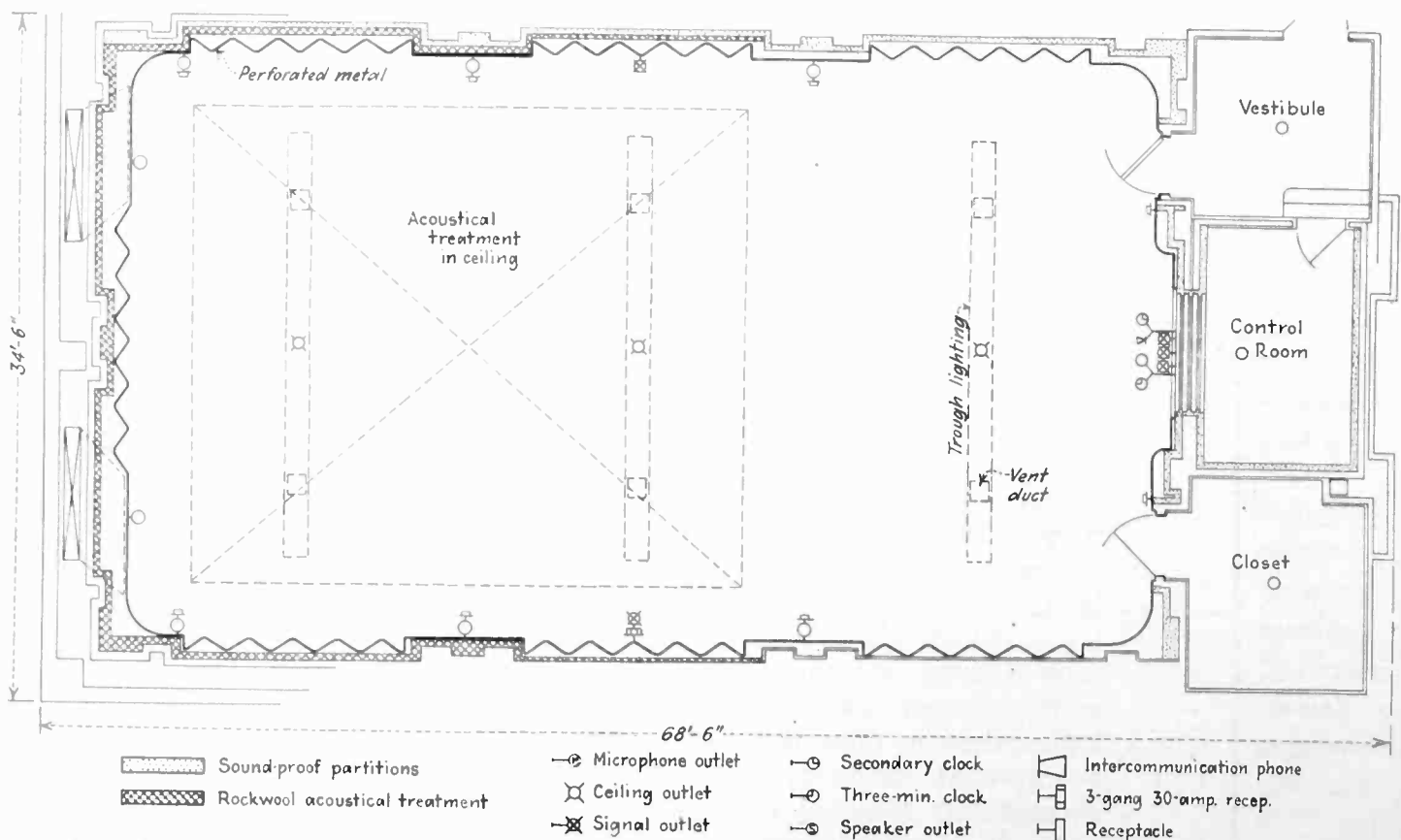

Floor plan of one of the large broadcasting studios of WCAU. The "live end" is at the right, nearest the control room. Toward the left it will be noted that

the rock-wool acoustic treatment of the walls increases in thickness, to 4 in. at the "dead end." The zig-zag wall lining is made up of plates of perforated metal

WCAU'S NEW STUDIOS

Dr. Stokowski's private sound laboratory.

Air-conditioning, and structural novelties

in an extremely modern manner, both in acoustic construction and in decorative treatment.

The two main studios—A and B (on the 7th floor) measure 32 feet by 55 feet, and 32 feet by 42 feet respectively, with 23-foot ceiling heights—and are designed to take care of maximum requirements for combined orchestra and accompaniment programs. The other studios (on the 7th and 8th floors), although smaller in size, are essentially similar to the larger ones in layout and construction—each forming a complete unit with its separate vestibule and control room.

The rough cinder block walls of all studios and auxiliary rooms have been isolated from each other as well as from exterior walls by air space, so that each room is a self-contained unit. In order to insure ideal conditions for sound transmission, the soundproofing and acoustical treatments were designed on a performance basis, specifying a definite reduction in decibels for sound transmission.

Soundproofing

The soundproofing treatment, which has been applied to the floors as well as to the walls and ceiling, insulates the finish work from the rough contours of the room, making the interior of each studio virtually a shell within the room. In the walls and ceilings this is accomplished by means of a special construction that employs cork "insulators" in the structural members that suspend the plaster. In the floors, known as "floating floors," this is accomplished by an arrangement of regularly spaced cork blocks that separate the finish floor thickness from the underfloor.

To guarantee complete freedom from outside interference, the rooms adjoining each studio have been soundproofed—the control rooms in the same manner as the studios and the vestibules, with a special acoustic tile. In addition, all openings between these rooms, such as doors and windows, have been specially treated. Observation galleries also have soundproofing treatment as well as double-sashed windows to completely insulate them from adjoining studios.

Methods of specifying performance

Definite specifications for the performance of acoustic materials were prepared. The requirements for the materials were rigid, insuring the correct acoustic condition, yet a wide range of choice of materials was permitted.

This was accomplished by specifying for each studio exactly the area to be treated, and at the same time setting maximum and minimum limits for the acoustic absorption at each frequency, to insure correct musical balance for the sound at the microphone.

Absorption is specified in units, each equal to one square foot of totally absorbing surface. Thus for one studio, after the areas to be treated are given, the following units of absorption were specified.

At 125 cycles—minimum 864, maximum 1,159. At

250 cycles—min. 1,096, max. 1,466. At 500 cycles—min. 1,150, max. 1,631. At 1,000 cycles—min. 1,275, max. 1,700. At 2,000 cycles—min. 1,170, max. 1,595. At 9,000 cycles—min. 1,191, max. 1,616.

Various arrangements of rock-wool blanketing are utilized to meet these specifications. The characteristic absorption is varied by controlling the air space between successive blankets of rock wool, as well as by changes

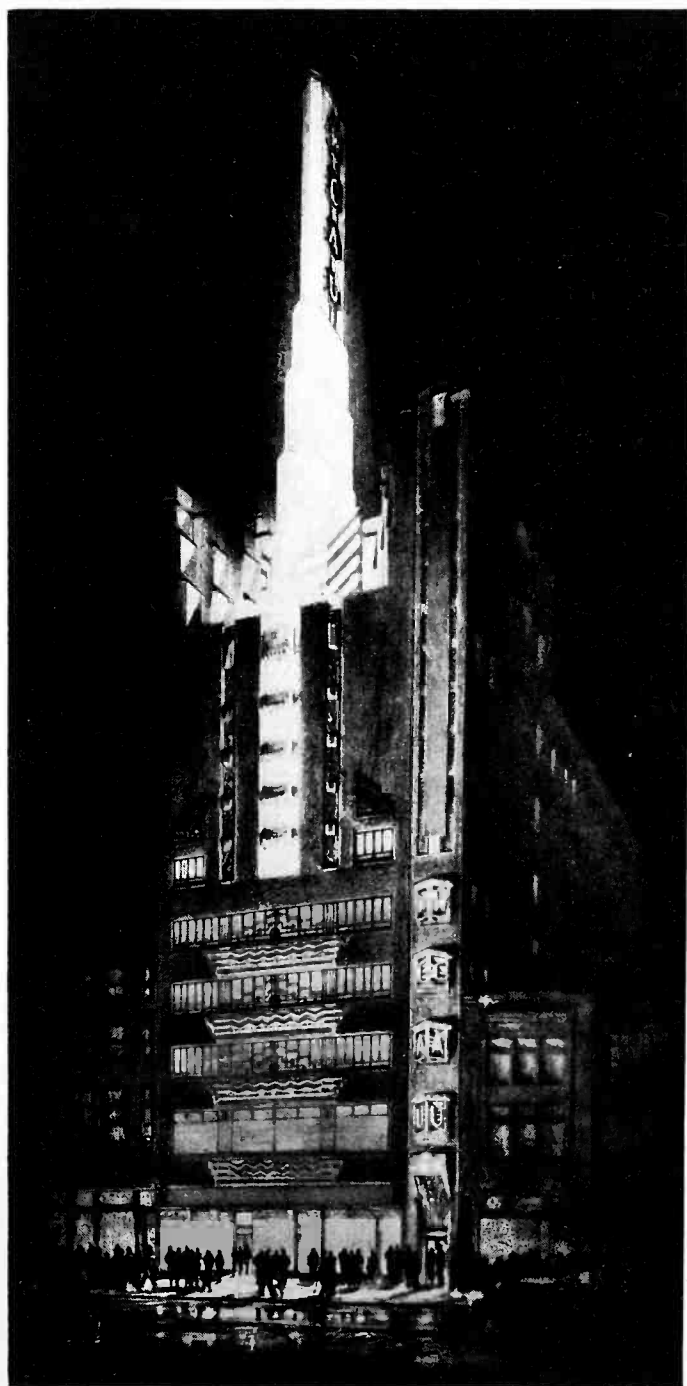

The new WCAU studio building at night. The 150-ft. tower of glass, steel and bronze, lighted by mercury-vapor lamps, makes the structure a landmark for miles

in the thickness of the rock wool employed. For protection and decoration, various coverings are used, including perforated metal and fabric.

In these studios as already mentioned, the so-called "live-end-dead-end" principles have been employed. These are the first large studios to incorporate this modern method of broadcast pick-up. Based upon the correct principles of musical production the artist or artists perform in an area of "live" reflecting walls, permitting them to render a natural, artistic performance. The microphone is located at some distance from the performers and in a "dead" region, surrounded by sound-absorbing surfaces, an ideal condition for pick-up. The sound at the microphone is thus like that which we have under normal, everyday conditions—blended and full.

In the large studios of WCAU special provisions are made in the live reflecting walls for diffusing the sound. Highly irregular surfaces reflect the sound waves in a broken pattern, reducing the sometimes apparent "room-tone," and minimizing the possibility of "bad spots" or acoustical interferences.

Control rooms and ante-rooms

Leading into each studio is a heavy-duty soundproof wood door, three inches in thickness, with a lead lining in the core, and a double rubber gasket is fixed on the door where it meets the stop. As an added precaution, a special lock and lever handle has been installed in each door which automatically controls the release of the handle and eliminates any clicking when the door is opened.

The studio and control room windows are composed of a triple sash, the three panels of the glass being $\frac{1}{4}$ in., $\frac{5}{8}$ in. and $\frac{3}{8}$ in. thick respectively, the $\frac{5}{8}$ in. thickness being placed between the lighter panels as an added protection against sound waves caused by any vibration. Each section of the sash and glass is separated from the other parts by cork insulation, as shown in the accompanying section drawing.

Each studio can be entered only through an ante-room, requiring the successive opening and closing of two silent doors, in order to gain ingress. The original plans called for an ingenious interlock between these two doors by means of photoelectric cells, making it impossible to open the door leading to the studio until the

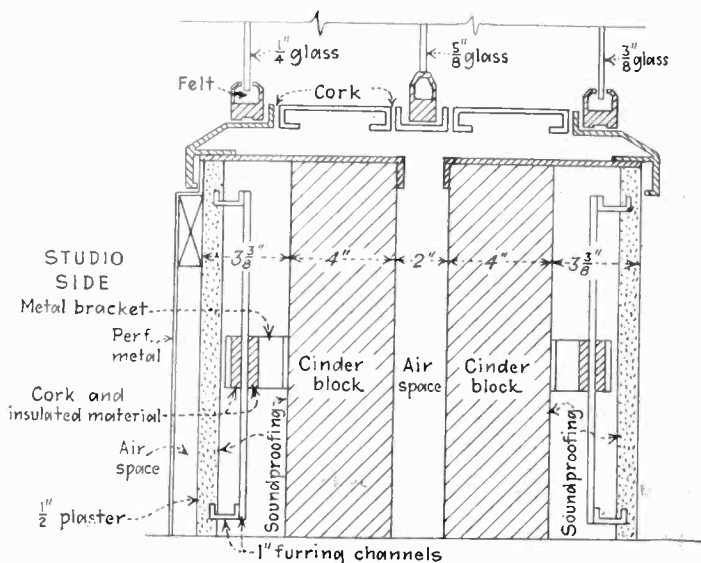

Cross-section through sound-proof triple-window between studio and control-room, showing how three glass sash are carried in cork without transverse members

corridor door had been closed. Intercepted light beams controlled the locks on the doors, so that both doors could not be opened at the same time. Objection was made to this noise safeguard, however, by the local fire marshall when the plans were reviewed, and so this feature was omitted.

Air conditioning

The studios are ventilated by a system of mechanical air conditioning, thereby eliminating the use of outside windows and safeguarding against extraneous noises. The metal ducts used in this system are suspended in all studios by hangers that are insulated with cork, and the ducts proper are packed in rock wool.

The average "quiet" air distributing arrangement is not suitable for broadcasting work as it is necessary that any noise be reduced to a level less than that which would register on the new, super-sensitive microphones. All WCAU air-carrying ducts are insulated on the outside and each air-opening into the studio is equipped with an elaborate sound trap. Every room is thus practically sealed for acoustical reasons. The necessity for these precautions is evident when one considers that the music of a large orchestra in one studio must not be heard in any adjoining studio.

The system, designed by Charles S. Leopold, consulting engineer of Philadelphia, and installed by the Carrier Engineering Corporation, provides for air washing, humidifying and cooling, each as required. The air supply is provided through openings in the ceiling, which are concealed by baffle plates that harmonize with the treatment of the studios and in the larger studios are incorporated in the lighting fixtures. The exhaust air is taken care of through openings near the floor which are screened by grilles of a modern design.

Speech input and microphones

Complete speech input and distribution equipment for the WCAU studios was designed and supplied by the RCA-Victor Company, whose Camden laboratories and plant are just across the river from Philadelphia, making it possible for the progress of the installation to be closely followed by engineers of the home office. The transmitter plant was also furnished by the RCA-Victor Company.

A feature of the WCAU studios is the use of twenty-two of the new "velocity" microphones, which were selected by J. G. Leitch, technical superintendent of WCAU, as affording improved pick-up, increased fidelity of reproduction, and greater convenience of manual handling in the studios.

An auxiliary 1-kw. broadcasting transmitter is mounted on the roof of the new studio building and can quickly be thrown in for broadcasting programs locally over the city of Philadelphia, in case of breakdown of lines or the 50-kw. transmitter located in the suburbs of the city.

Dr. Leon Levy is president of the Universal Broadcasting Company operating Station WCAU, and is also treasurer of the Columbia Broadcasting System. Engineering features were designed under the supervision of E. K. Cohan, technical director of the Columbia Broadcasting System. The Acoustic Consulting Department of Electrical Research Products, Inc., were consultants on acoustic and sound-proofing problems. Robert Heller of New York City was the architect responsible for completing the new studios and building.

Curve plotter and comparator

for laboratory and
production test uses

By SAMUEL ISLER

MANY devices in use for curve tracing and comparing are useful in a highly special way, others are of more general service; but most are rather troublesome to set up and require careful manipulation, in addition to being expensive in initial cost and upkeep.

A simple and inexpensive system¹ has been developed at the laboratories of Wired Radio, Inc., at Ampere, New Jersey, for use in testing receiving and transmitting filters for frequency and overall output characteristics.

As shown the instrument is set up in its simplest form, for radio-frequency test; it is an easy matter to add the necessary apparatus to make it perform for any desired electrical input and output characteristics.

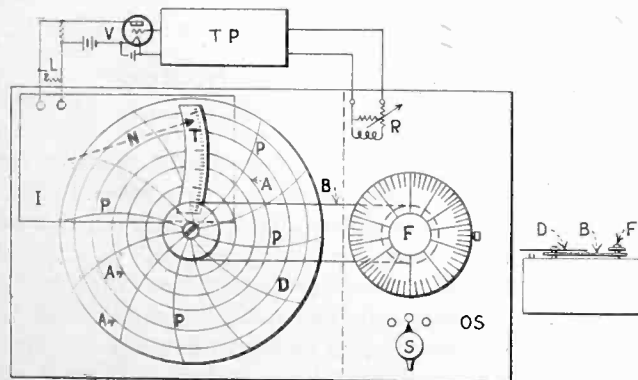

Schematic of automatic curve plotter

Oscillator OS has a constant or fairly constant output over the test ranges. Its frequency varies stepwise by means of the three-position switch S, and continuously by means of the dial F. The output of the oscillator is fed into the low impedance pad R. Dial F is geared (shown belt-connected by B) to a rotatable, removable, transparent celluloid disc D, which conforms in angular position with dial F throughout its entire travel. The apparatus under test TP has its input connected to the pad R, and its output is led to a vacuum tube voltmeter V, which is actually within the shielded case but shown external for clarity. The indicating meter I, provided

¹U. S. Patent No. 1,857,959.

with a protective calibrated shunt L, has a long needle N, and is so positioned that the needle tip T deflects in an arc substantially along a radius of the transparent disc D, upscale on the meter, towards the center of the disc, for higher voltage indications. A flash-light bulb, itself hidden, illuminates the needle tip T. The disc D is provided with polar radial lines P,P,P, and concentric annular lines A,A,A. The oscillator is calibrated in terms of dial settings on F for the three positions of switch S; this gives the frequency correspondence of the radial lines P,P,P. Pad R is calibrated in terms of applied voltage. Voltmeter V is calibrated thus giving voltage values to the annular lines A,A,A, which should be directly readable in voltage or voltage ratios.

For laboratory tests, beginning with low applied voltage and with meter shunted, dial F is rotated till the peak response within the frequency range is observed

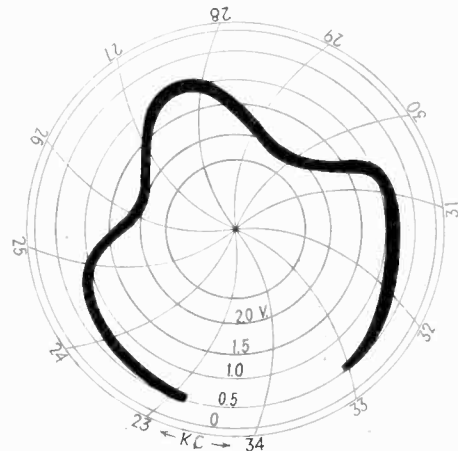

Specimen standard curve made from
three-mesh filter

on getting maximum deflection on I. Changing L, then R to give a reasonably large deflection, the peak ratio of output to input voltage can be immediately had from the calibration curves, as can the frequency at which this maximum occurred. If a complete graph is desired, the dial F is rotated through the frequency band and the position of the needle tip dotted in on a sheet of coordinate paper held to disc D.

When it has been decided that the test piece is sufficiently satisfactory to be used as a standard for production testing, its curve is drawn directly on the celluloid disc D, the thickness of the line drawn being determined by the allowable voltage and frequency deviations from the standard which would be considered acceptable. It is then merely necessary to observe, with another piece in the test position, whether the needle tip, T, shows outside the thickened line graph of the standard to prove whether it conforms, with permitted differences, to the standard. With proper connection jigs, pieces can be compared at the rate of one a minute.

Though no actual application of this method to automatic production testing has been made, the following suggests itself as a means for so doing. To the tip of the meter needle is attached a small reflecting prism. With only the prism reflection of the hidden flashlight bulb showing through the meter glass, the rest being made opaque by paint, and with the thickened, opaque, acceptable curve drawn above on the disc, any deviation of the needle tip from the curve will be indicated by light coming through the otherwise transparent disc. This is detectable by means of a photocell, which can be made to ring a bell or in some other way signal the operator that the piece under test is not up to the mark.

Directive antennae for broadcast stations

By **RAYMOND M. WILMOTTE**
Consulting Engineer

THE limiting feature in the development of broadcasting has been the interference between stations and the economic manner in which the energy of stations could be distributed over the country. This, in fact, has been the problem which the Federal Radio Commission has to face and solve. The only tools available to meet the national requirements have been frequency allocation and power limitation; and considerable benefit has already been achieved by the judicious application of these two.

The use of another very powerful tool to meet the problem has recently been shown to be possible when station WFLA in Florida eliminated the interference it was causing in Milwaukee by the use of a directive antenna.

Directive antennae are not new; they have been known since the early experiments of Herz and Lodge; they have been applied very generally to short wave point-to-point communication ever since the original erections built by C. S. Franklin of the Marconi Company for the British Post Office. The development at station WFLA employs no fundamentally new principle in the theory of directive antennae, but it involves the solution of new problems which are peculiar to broadcasting and to the frequency band used. The apparatus problem, as is to be expected, is entirely different from that used for short wave stations.

Substitution of a directional antenna instead of a conventional structure enabled WFLA to increase its power to 1000 watts from 250 and thereby give its local listeners better service and at the same time reduce interference to WTMJ on the same frequency assignment.

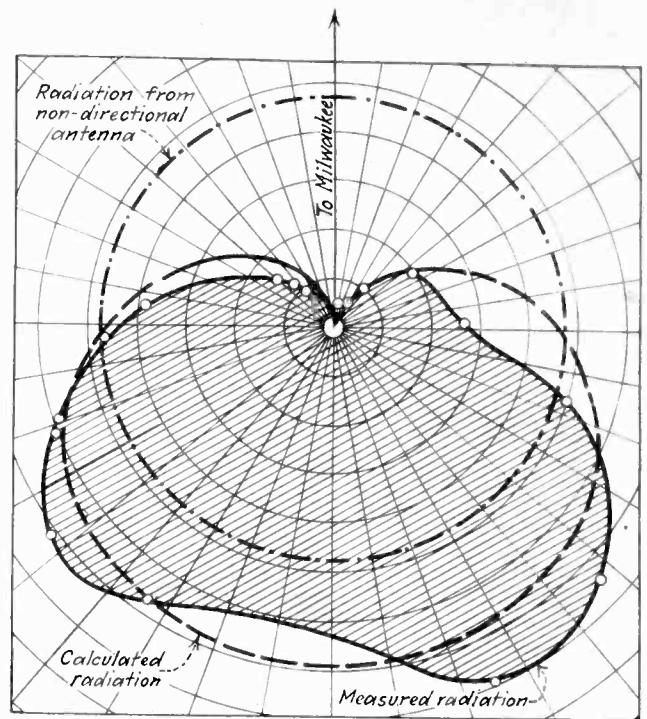

Fig. 1—Radiation of directive antenna for WFLA used at night

From a national and international point of view, the advantage in directive antenna systems lies in the possibility of locating stations on the same or adjacent frequencies and designing the radiating system of these stations so that they do not cause interference in each other's service area. Not only is it possible to locate stations employing a suitably designed directive antenna closer together than they are at present but it is also possible to allow these stations greater radiating power.

The economic distribution of radiation

Individual stations using such a system can improve their economic coverage in one of two ways. The first way is to view the problem from the standpoint of the Federal Radio Commission and investigate how the interference on the same or adjacent frequencies can be reduced. The station can then make an application to the Federal Radio Commission either to increase its power or move to a more remunerative location, if in exchange it takes the necessary steps to reduce the interference caused with other stations.

The second way is to employ the radiated power which the license permits as effectively as possible. Up to the present broadcast stations have been radiating substantially equally in all directions. A station should make an economic survey of its territory and then make an estimate of the value of the different directions. This evaluation should be reduced to signal strength and then the antenna system should be designed to meet these requirements. In many cases, the economic survey map may be very different during the day and during the night; it may also be different for different types of programs; in such a case the antenna should be designed so that the radiation distribution around the station can be altered to meet the different demands at the different times.

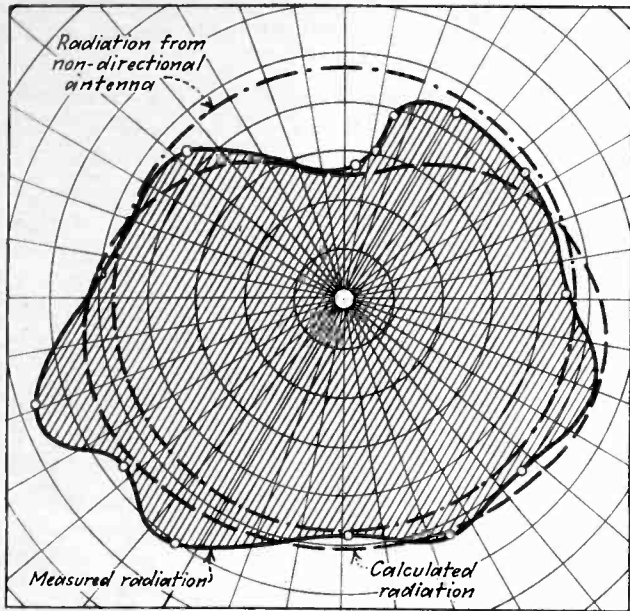

Fig. 2—Radiation from non-directional antenna of WFLA used in daytime

On general grounds, it is not to be expected that uniform distribution in all directions is the most economical manner of employing the power available, and it is to be expected that directive antennae would improve the economic coverage of the great majority of stations.

The first application of a directive antenna system for broadcasting to be recognised by the Federal Radio Commission was carried out by the author on station WFLA at Clearwater, Florida. A brief description of this installation was given by Commander T. A. M. Craven in *Broadcasting*, Vol. 3, July 1932, p. 13.

The figures in the present article show the results of the field strength survey made by the Department of Commerce for the Federal Radio Commission and given in their official report to the commission.

Station WFLA was causing interference within the service area of station WTMJ situated in Milwaukee and was ordered in consequence to reduce its power from 1,000 watts to 250 watts until it made the necessary structural changes to eliminate the interference it was causing.

The ray that reaches Milwaukee is a very low angle ray. A directive antenna was therefore designed so that the low angle radiation in the direction of Milwaukee was reduced to such a value as to eliminate interference. The polar diagrams of Fig. 1 shows the radiation distribution on different directions. The agreement between the predicted and the measured results is more than satisfactory.

Antennae for day and night use

Since no interference was produced in Milwaukee in the day-time, it was not necessary to use a directional antenna except at night. The antenna was therefore designed to give the more circular pattern shown in Fig. 2 in the day-time. This pattern can be adjusted to give the most economical distribution of radiation and it will be noted that the distribution is not uniform; the signal is greater in the South than in the North.

Figure 3 shows the 1 millivolt contours. The contour used at night is given in the report of the Department of

Commerce; that used during the day was calculated from Fig. 2 and the attenuation curves taken in different directions by the Department of Commerce. The location of the station is such that the reduction of the signal in the direction of Milwaukee produces very little reduction in the population served.

A feature of the antenna installation at WFLA is a switching arrangement which changes the directivity of the system. By means of a single switch it is possible to change the day radiation pattern shown in Fig. 2 to the night pattern of Fig. 1 without interrupting the program.

The results of the measurements in Milwaukee are best given by quoting from the report of the Department of Commerce to the Federal Radio Commission:

"At no time during the observations on the 620 Kc. channel between the hours of 1.00 a.m. and 6.00 a.m. E.S.T. on May 10, 13, 14 and 15 when, it is assumed, the new transmitter was in operation, was a sufficient signal received from WFLA to permit measurement.

"During the observations on the 620 Kc. channel between the hours of 1.00 a.m. and 6.00 a.m. E.S.T., on May 11 and 12, when the old and the new transmitters were scheduled for alternate operation the only measurements obtainable were those made while the transmitter announced as No. 2 (old) was in operation. The call letters WFLA were heard faintly, however, on occasion when the transmitter indicated as No. 1 (new) was scheduled for operation."

The signals measured on the old transmitter at Milwaukee varied from 0 to 500 microvolts per meter

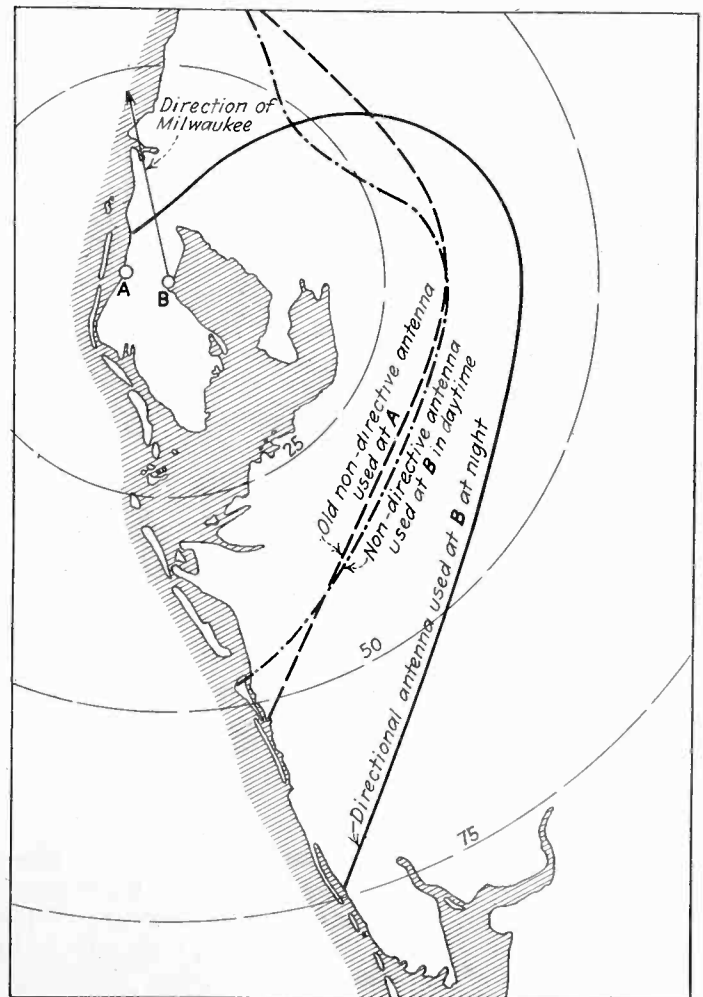

Fig. 3—One-millivolt contour of WFLA service area with 1000 watts

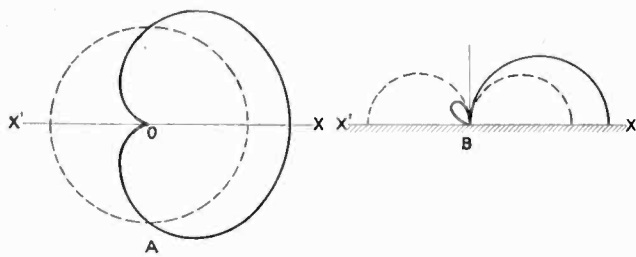

Fig. 4—Simple directive antenna with high-angle radiation in one direction

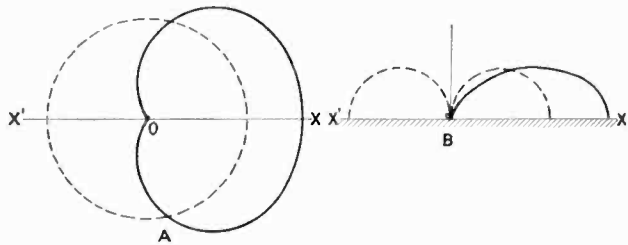

Fig. 5—Directive antenna with negligible radiation in one direction

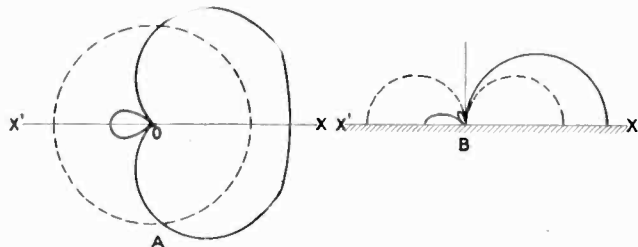

Fig. 6—Directive antenna with small radiation in two directions

with an average of about 120 microvolts. Station WFLA with the permission of the Federal Radio Commission is now operating regularly with the new antenna on its old power allocation.

Technical problems involved

There has been a great deal of data accumulated on the propagation phenomena at frequencies within the broadcast band; and we can now predict by no means accurately but with a fair degree of approximation what will be the characteristics of the sky ray, its strength, and its point of return to the ground. Direction-finding experiments, moreover, have shown us that these rays follow the great circle paths and are not appreciably deflected from their vertical planes of propagation.

If interference is to be prevented over a certain area, the ray which starts at a certain angle of elevation to reach that area must be made very weak; and the signals transmitted at angles close to this particular direction must also be kept weak to allow for the known variations in the conducting layer of the atmosphere. When the signal in those directions is made and kept sufficiently weak, there can be no danger of a strong signal ever reaching the area which is to be protected.

The directive system must be designed to meet such requirements and it is just as important to consider the

radiation distribution in the vertical planes as in the horizontal plane. For instance, a certain simple directive system produces a radiation distribution shown in Fig. 4 where the dotted curves are for a non-directional system. It will be seen that in the direction OX' the signal is weak only at low angles of elevation. At a distance of 50 miles or 1000 miles in the direction of OX' the signal will be weak, but at a distance of 200 miles the signal, though weaker than with an ordinary non-directional antenna, may be very appreciable. On that account it may be necessary to employ another system; a system which can produce a radiation distribution such as is shown in Fig. 5, in which there is practically no radiation at any angle in the vertical plane in the direction OX' may prove more satisfactory for certain cases.

Fig. 6 shows another type of radiation distribution pattern, in which the signal is very small in two directions. These two directions can be controlled by suitably designing the directive antenna.

There are innumerable possible types of radiation patterns. The problem confronting each station must be considered on its merits. A directive antenna system consists of a number of radiators excited with a certain amplitude and phase relation to each other. It is important to measure both the phase and the amplitude relations; it is also essential that these factors should remain the same relative to each other irrespective of weather conditions.

Probably by far the most important feature in the design is to be able to have an instrument which can read correctly the phase and amplitude relation which exists at the radiators, so that any small variation that may exist may be corrected easily by the operator. It is very seldom that correction will be required, but the possibility of correction should be available if the optimum conditions are to be obtained at all times. The problem of connecting such an instrument is particularly difficult since the instrument can only be connected inside the transmitter building, that is at the ends of the transmission lines remote from the radiators. It is possible, however, by suitable design to obtain the desired result and compensate automatically for errors which would normally arise with changes of weather (which may affect both the impedance of the radiators as well as the characteristics of the transmission lines).

There is a phenomenon which arises when special precautions are not taken. It is not usually desirable in a broadcast station to drop the signal down to absolute zero in any direction; it is preferable to leave some signal even in the direction in which it may be desirable to eliminate interference, in order to give some service in that direction to the population in the immediate neighborhood of the station. Unless, however, certain precautions are taken, the signal in the direction of the minima is very distorted and may even become unintelligible. This undesirable distortion can be reduced and may even be eliminated completely without increasing the strength of the minimum signal.

Every new development involves new problems. The new problems in the application of directive antennae to broadcasting occur both in the design of the antenna system and in the method of coupling the antenna to the transmitter. These two elements are involved in the solution of the difficulties mentioned above and these difficulties can now be overcome completely and, for the most part, automatically.

Editor's Note.—Manuscript received August 30, 1932, and in final form November 25, 1932.

Electrons in the Day's News

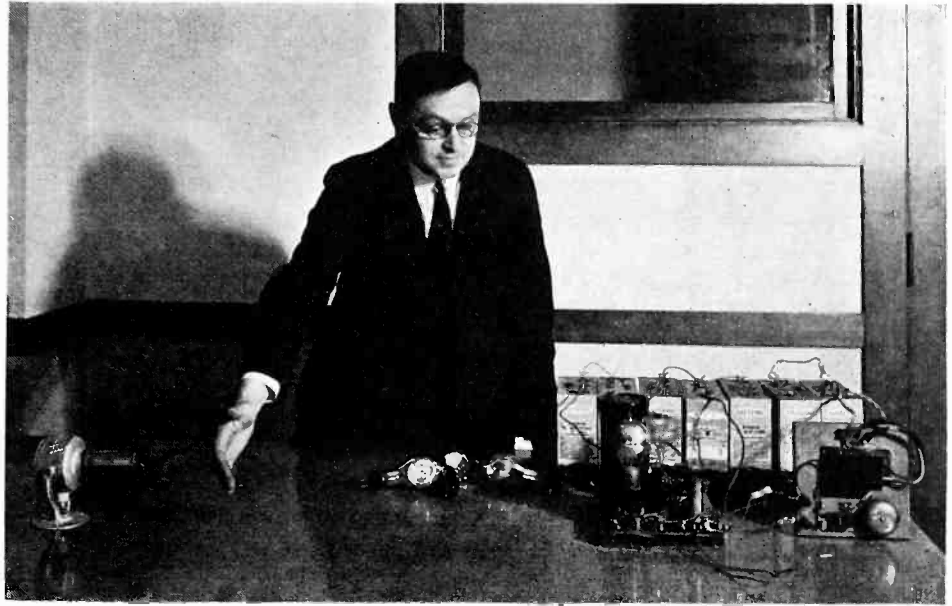

Dr. Harvey Rentschler, in his laboratory at Bloomfield, N. J., demonstrates an infra-red burglar detector, which he has later made "unbeatable" by employing an ultra-violet beam to outwit the scientific-minded maulauder.

N. Feather, of Trinity College, Cambridge, England, disintegrates the oxygen nucleus by employing the neutron method used by Walton and Cockroft to split the lithium atom.



Ivan Eremeeff, in his laboratory at 5807 Germantown Avenue, Philadelphia, with his electronic musical instruments which are played by completing the circuit between the keys and the stools with metal conducting tops. Varying the finger pressure controls the volume of tone. One of the pedals effects changes in quality of all tones.

Reducing man-made static

By **GLENN H. BROWNING**
Consulting Engineer

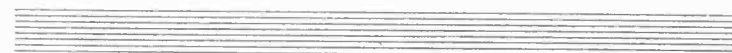

IN many localities, "man-made" static has been so bad that radio reception is seriously impaired. Even local programs suffer in many places, particularly apartment houses with d.c. elevator motors and other congested populations with many forms of interference-producing apparatus where the difficulty of erecting an antenna clear of local noise combines with the high intensity of disturbance to make reception almost impossible.

The logical place to eliminate such interference is at the source, of course, but until manufacturers of home and industrial appliances are forced to install filters when the units are manufactured radio listeners must rely on reducing the noise locally.

The Tobe Deutschmann corporation has, during the past five years developed considerable apparatus to aid in the mitigation of this problem. Filters to be installed at the scene of noise are available; an interference meter has been placed on the market for the use of service men, power companies and others, enabling the operator to measure the magnitude of the disturbance and aid in its location.

The noise problem may be solved indirectly by another method. That is, interference may be greatly reduced if not entirely eliminated at the radio owner's location before it reaches the input to the receiver. If the radio set itself is carefully shielded, there are only two ways that noise may enter. The first is through the antenna ground or pick-up device, and the second through the 110-volt line. A careful investigation of interference coming in over the antenna system shows conclusively that a large percentage of the disturbance is picked up on the "lead-in" wire. There are two reasons for this: First, the vertical component of the interfering electrostatic field is much greater than the horizontal component as may be noted by reference to Fig. 1 where the vertical and horizontal intensities of interference in microvolts per meter emitted from an electrical appliance are shown at various distances from the apparatus. Second, the electric light lines nearly always act as carriers and radiators of noise, and the "lead-in" almost without exception is close to these circuits. Therefore, if the "lead-in" is shielded and the horizontal part of the antenna advantageously located with respect to interference, noise emitted from the loudspeaker will be greatly reduced. Shielding the "lead-in," however, places a large capacity across the antenna resulting in a transition loss due to its low impedance. This necessitates the insertion of an impedance matching network between the antenna and the input to the re-

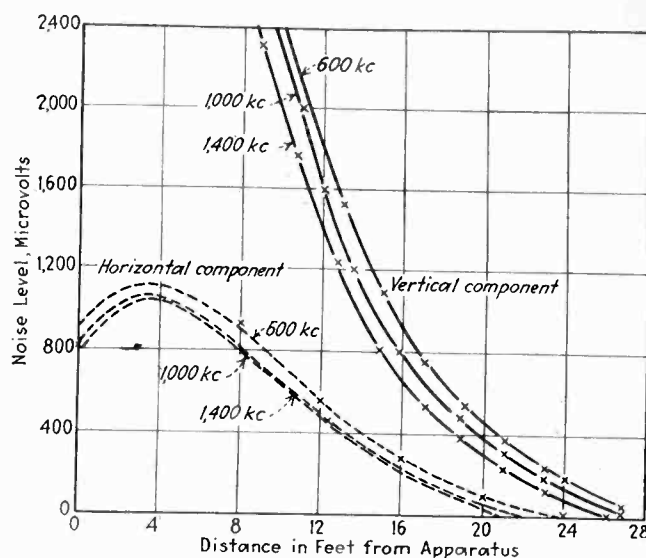

Fig. 1—Direct radiation interference from an electrical appliance

ceiver. Otherwise, the reduction of signals will be so great as to eliminate all but the very powerful stations. For no transition loss, this network should have an impedance looking into the antenna equal to the impedance of the antenna, and looking into the input to the radio set its impedance should equal the set's input. Referring to Fig. 2, the impedances between 1 and 2 and 3 and 4 should be equal as well as those between 5 and 6 and 7 and 8. Then if the inserted structure had no loss at all; that is, no resistance, there would be no reduction of signal due to its insertion. In fact, if the receiver's input did not match the impedance of the antenna the insertion of such a low dissipative structure would raise rather than lower the signal output. Let us determine the impedance at various frequencies of the ordinary antenna which is represented in Fig. 2 where C_A is usually taken as 200 μf where L_A is usually 20 μh , and R_A is usually 25 ohms. The impedance between points 1 and 2 is

$$Z_A = \sqrt{R_A^2 + \left(L_A \omega - \frac{1}{C_A \omega} \right)^2}$$

Substituting the numerical values in the above equation, we see that at 550 kc. the antenna presents an impedance of 1,460 ohms and at 1,500 kc. its impedance is 345 ohms.

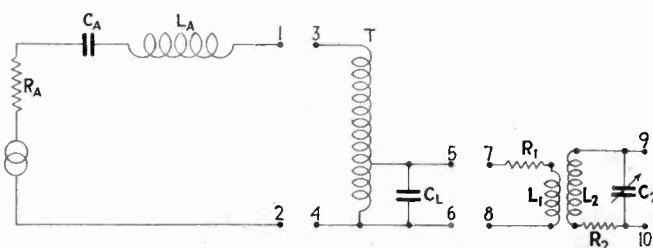

Fig. 2—Equivalent circuit of antenna, coupling system and receiver

Next let us consider the impedance looking into the radio receiver. Most receivers are designed with an input such as is shown between points 7 and 8 in Fig. 2. If we let R_1 be the resistance inherent in the coil whose inductance is L_1 and R_2 be the resistance in the tuned

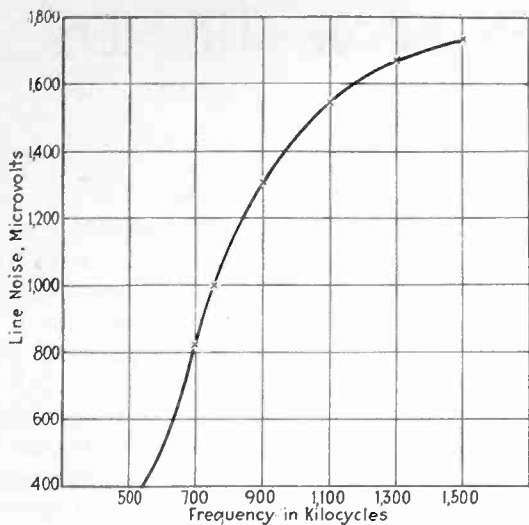

Fig. 3—Line noise from an electrical appliance as a function of frequency

circuit L_2C_2 ; and M the mutual between L_1 and L_2 then we may solve for the impedance looking into the circuit. As in all similar problems it is convenient to make the following abbreviations:

$$\omega = 2\pi \text{ frequency}; \omega_0 = \frac{1}{\sqrt{L_2 C_2}}; \theta = \frac{\omega_0}{\omega}; \eta_1 = \frac{R_1}{L_1 \omega}; \eta_2 = \frac{R_2}{L_2 \omega};$$

$$\tau = \frac{M}{\sqrt{L_1 L_2}}$$

These abbreviations are chosen because they can be given numerical values. Let X be the total reactive and R the total resistive component.

$$\text{Solving, } X = L_1 \omega \left\{ 1 - \frac{\tau^2 (1 - \theta^2)}{\eta_2^2 + (1 - \theta^2)^2} \right\} \dots \dots \dots (1)$$

$$R = R_1 \left\{ 1 + \frac{\tau^2 \eta_2}{\eta_1 [\eta_2^2 + (1 - \theta^2)^2]} \right\} \dots \dots \dots (2)$$

It may be shown that when C_2 is tuned for maximum voltage across it (maximum voltage on the grid of the first amplifier tube) that

$$\theta^2 = \frac{\eta_1^2 + 1 - \tau^2}{\eta_1^2 + 1} \dots \dots \dots (3)$$

In the case of a well designed coil η_1 and η_2 will be practically constant over the wave band from 550 to 1500 kc. Their values will depend somewhat on the type of coils used but in general the values will be between 0.015 in a

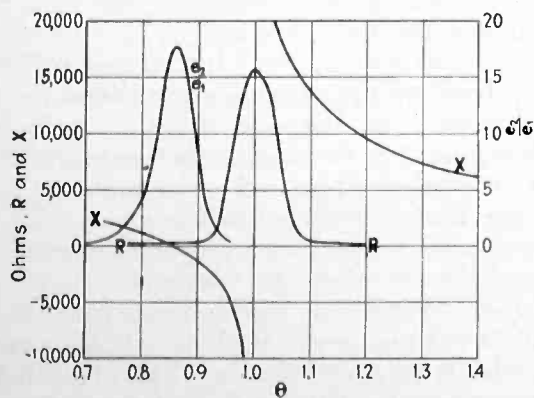

Fig. 4—Reactance and resistance as receiver is tuned to resonance

rather mediocre coil to 0.006 in a very good one. For the sake of computation we shall assume

$$\eta_1 = \eta_2 = .01$$

$$\tau = .5$$

Consequently to a very close approximation equation 3 reduces to

$$\theta^2 = 1 - \tau^2 \dots \dots \dots (4)$$

if $\eta_1^2 \ll 1$

Equation (4) gives the value of θ at resonance under above conditions. Substituting (4) in (1) we find that the reactance at resonance is:

$$X = L_1 \omega \left\{ 1 - \frac{\tau^4}{\eta_2^2 + \tau^4} \right\} \dots \dots \dots (5)$$

The resistance at resonance is:

$$R = R_1 \left\{ 1 + \frac{\tau^2 \eta_2}{\eta_1 [\eta_2^2 + \tau^4]} \right\} \dots \dots \dots (6)$$

Substituting the numerical values as given above in 5 and 6 we find that:

$$X = 0.0001 L_1 \omega$$

$$R = 5.0 R_1$$

Therefore, if C_2 is tuned to resonance the reactive component looking into the receiver is practically zero and the resistance is about five times the resistance of the primary coil. The primary coil in various receivers differs a great deal in some cases having an inductance of as much as 2 or 3 mh and consequently a resistance of approximately 125 ohms at 1000 kc. In other cases the inductance is as low as 20 μ h, and the primary has a resistance of 1.2 ohms.

It will be noted that a primary coil with an inductance between the two values best matches the standard antenna impedance. As the impedance looking into the set is almost a pure, but variable resistance (if η_1 is nearly constant as found in practice, R_1 will vary directly with frequency) and the antenna impedance varies inversely, approximately, with frequency an impedance match can only be made at one frequency preferably one near the middle of the band.

To give a better picture of the whole situation curves are drawn in Fig. 4, showing the reactive component and resistive component as θ is varied. So that the point of resonance when C_2 is tuned for maximum voltage may be indicated, the resonance curve of voltage across 9-10 which we will call e_2 divided by the voltage across 7-8 which we will call e_1 , is plotted on the same curve against θ . In these curves the following values are chosen:

$$\eta_1 = \eta_2 = .01$$

$$\tau = .5$$

$$L_1 = .001 \text{ henrys}$$

$$L_2 = .0002 \text{ henrys}$$

$$f = 1,000. \text{ kc.}$$

As will be observed by reference to the curves, the reactive component has a large variation. It may be shown by differentiating equation (1) and equating to zero that X is a maximum when $\theta^2 = 1 + \eta_2$ and a minimum when $\theta^2 = 1 - \eta_2$. Thus

$$X_{max} = L_1 \omega \left\{ 1 + \frac{\tau^2}{2\eta_2} \right\} \dots \dots \dots (7)$$

and

$$X_{min} = L_1 \omega \left\{ 1 - \frac{\tau^2}{2\eta_2} \right\} \dots \dots \dots (8)$$

[Please turn to page 368]

RADIO ENGINEERS DISCUSS NEW TRENDS

TECHNICAL problems and circuit trends occupying the attention of radio set and tube engineers were discussed at length at the Rochester Fall Meeting of the I.R.E., November 14 and 15 when nearly 200 of these engineers met at the Hotel Sagamore.

At the first evening session B. V. K. French entertained both radio engineers and photographic hobbyists by comparing in a masterly fashion the technical aspects of the two arts. At the banquet Arthur Van Dyck, after making an excellent start on the vastly important subject of electronics (radio principles applied to other fields) seemed to get off the course and into the rough making it necessary for George Clark, in his inimitable fashion, to put radio matters and personalities into their proper places.

In the final technical paper of the meeting, Kenneth Jarvis threw caution to the winds and discussed what radio engineers might do next in stimulating interest in radio by the use of additional "gadgets." According to Mr. Jarvis there are certain requirements of every radio and the most expensive in the near future will not be much better than the cheaper sets in respect to these fundamentals. Thus all receivers must select the required program and keep out interference on an adjacent channel; all receivers must go down to the noise level in sensitivity; and all sets must have good tone fidelity. The higher priced receivers will be differentiated from the cheap ones by the employment of additional services, for example automatic volume control, automatic tone control, muting systems, etc. In time these services will become fundamental and the cheap sets will be favored with these services too. By that time other gadgets will have been developed.

What may these new services be? The audio band between zero and 30 cycles is now unused because no loud

speaker and no ear will be responsive to such frequencies. Therefore this region might be utilized as an automatic gain control cranking up the audio amplifier of a receiver when the input at the transmitter goes up and vice versa. This could be done by an additional volume-control emission from the broadcast station. Or a signal might be put on the air from each station which, appearing in this 0-30 cycle band, would indicate the call letters of the station or some other desired distinguishing feature. The volume control feature would permit transmitting greater volume level changes than are now possible. Other uses of this region might be a time service, or facsimile system for news or visual advertising.

Another departure from current practice, suggested by Mr. Jarvis, would be detectors that would tolerate, or even enjoy, modulation percentages in excess of 100 per cent. For example bad distortion is now caused by selective fading where the carrier goes down more than the sidebands causing an effective increase in modulation. Receivers might be developed which would handle cases where modulation of several hundred per cent was experienced. If such high modulation became the practice the interference range would be decreased.

Still another suggestion was the use of very low impedance output tubes. At the present time, to get high output into loud speakers class B amplifiers are used. During periods of low signal these tubes present a high impedance to the loud speaker. Therefore transients in the speaker are high with corresponding distortion. Low impedance tubes would damp the speaker confining transients to a few cycles or fractions of a cycle. Mr. Jarvis had other suggestions all of which gave the impression that the radio industry had much to live for and that time might make substantial changes in the services a radio set performs.

Reducing man-made static

[Continued from page 367]

It should also be observed that η_1 does not enter into the reactance equation. Therefore, provided τ and π_2 do not change, the shape of this curve remains constant. Such is not the case, however, with the resistive component and tuning curves. If the value of η_1 is increased (a resistance added in series with R_1) the curve for R flattens out having a less dominating peak though the peak value remains at the fixed point $\theta = 1$.

In the case of the tuning curve the maximum occurs at the value of θ given in equation (3) and is dependent on the value of η_1 . Therefore, as the value of η_1 is increased the maximum moves to the right in Fig. 4, and when $1 \ll \eta_1^2$ it will be very close to $\theta = 1$.

It is readily seen from the above that radio receivers may differ widely in their input impedance but that most sets do not have as high an impedance as would be expected. It is not within the scope of this article to analyze mathematically the input and output impedances

of the impedance matching structure shown in Fig. 2. However, with a well designed low resistance transformer it is possible to match the impedance of the antenna and at the same time the impedance looking into the set in the case L_1 has a value less than L_2 . In fact under those conditions the signal strength from a given antenna is nearly always increased. In the case that $L_1 > L_2$ a second transformer located at the receiver is advantageous.

Thus a shielded "lead-in" not only eliminates a great deal of "man-made" static but in many cases the signal strength is increased by using a properly designed transformer at the point where the antenna connects on to the "lead-in." In installing such a device care should be taken that the antenna proper is placed where its effective height will be as great as possible. The writer has seen installations where the flat top part of the antenna was only a few feet from a grounded metal roof. In this case the "lead-in" was a much better antenna than the flat top.

Beat frequency oscillator control

determining proper plate shape

G. F. LAMPKIN

A MOST simple method of arriving at a logarithmic condenser for the beat frequency oscillator is based on an experimental fact. The fact is that, for all practical purposes, the beat frequency is a linear function of the capacity increment in the one oscillating circuit.

For design purposes, assume values for lumped inductance and capacity, and the maximum desired beat frequency. Thus, if $L = 400 \mu\text{h}$. and $C = 2070 \mu\text{f}$., the fixed frequency,

$$f = \frac{10^6}{2\pi \sqrt{400 \cdot 2070}} = 175,000$$

To yield the 10,000 cycle frequency a total capacity increment, C_0 , is needed. Thus,

$$f = 10,000 = \frac{10^6}{2\pi \sqrt{400(2070 + C_0)}}$$

and $C_0 = 258 \mu\text{f}$

Since the beat frequency is proportional to C_0 , on semi-logarithmic paper in Fig. 1, C_0 rather than beat frequency is plotted versus dial rotation. If a lower limit of 40 cycles is desired, a capacity of 1.03 μf . is determined, and the terminal points of the plot are (0, 1.03) and (100, 258). Then for a given increment of dial rotation $\delta\theta$ the resultant capacity increment C_0 can be read from the formulas,

$$C_0 = \frac{K\delta}{t} \text{ and } A = \frac{1}{2} r_1^2 \theta$$

with proper attention to units, the condenser can be determined.

The analysis shows that, to be satisfactory for beat-frequency-oscillator use, a condenser must have a capacity characteristic of very high curvature. Even that of a straight-line-frequency condenser is not sufficient at low values of beat frequency. Below are given empirical data for modifying one of the straight-line-frequency condensers.

Disassemble a National Type EC-500, 31-plate, 270° rotation, condenser. With drawing instruments and tin snips lay out and cut one, two, five, and eight rotary plates as in Fig. 3a, b, c, and d, respectively. Reassemble

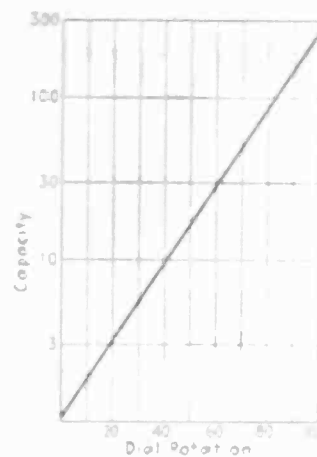

Fig. 1 — Calibration of condenser vs. dial rotation

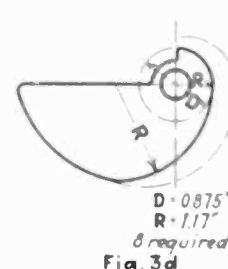
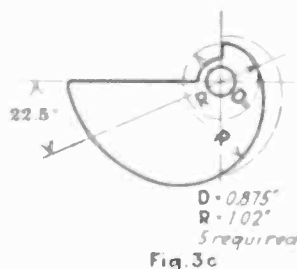
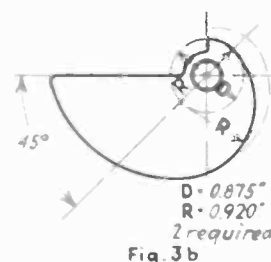
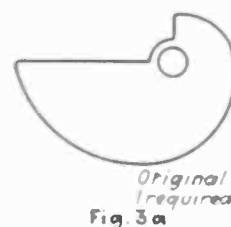

Fig. 3—Plate dimensions for remodeled capacitor

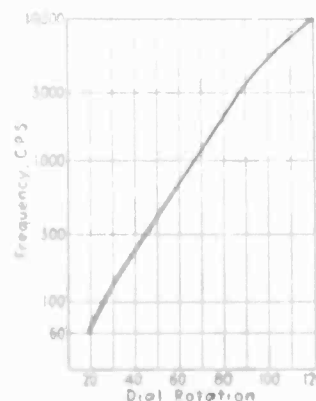

Fig. 2 — Calibration of final oscillator

the plates and condenser. For the dial simply cut a 6-inch diameter circle of 14-gauge gray aluminum, center and mount it on a General Radio Type 137-H knob. In calibration mark the points lightly with a scribe, including a reference point on the edge of zero beat and marks at the limits of rotation. Remove the dial and make deeper radial indentations with a wood chisel or knife edge. Use $\frac{1}{16}$ -inch steel figures to mark appropriately the points.

The revamped condenser has a maximum capacity of 490 μf . When used with a 440 μh . coil and a fixed 3000 μf . condenser the maximum beat frequency is slightly over 12,000 cycles.

How closely the modified condenser approaches the logarithmic calibration is shown in Fig. 2. The convenience of the directly calibrated dial is most appreciated in actual use. The calibration of the original model has remained accurate to within 3% for over a year.

HIGH LIGHTS ON ELECTRONIC

Electronic chimes in bell-less church-tower at Detroit

INSTALLATION OF WHAT is believed to be the most complete and elaborate system of electric chimes in the world has been completed in the lofty Crucifixion Tower of the Shrine of the Little Flower, near Detroit, Michigan, which is presided over by the famous radio priest, the Rev. Charles E. Coughlin.

The new carillon, which is comparable in volume to the most elaborate and weighty bell chimes, although it does not utilize bells, is the gift of an anonymous donor. The bell-like tones of the new carillon are all produced electrically, the lowest note on the keyboard being equal to the tone of a forty-ton bell, according to engineers of the RCA Victor Company who designed and installed the new system. The instrument also includes a special reproducing apparatus through which organ music may be played.

The new electric carillon represents a distinct advance in the control which the carillonneur has over his instrument, in that its entire musical range is controlled from a forty-nine note, piano-like keyboard, beginning with C below middle C. By pressing the keys lightly, light strokes are produced on the carillon; pressing the keys all the way down results in a volume of sound which may be heard at a great distance, if desired. As the keys are depressed, tiny hammers strike tuned metal reeds. The musical vibrations produced are electrically amplified into bell-like tones and sent out through a special sound

projection system located at the top of the tower. The direction of the music may be regulated by cutting out any of the six individual sound projectors. The electric carillon system is expected to prove especially valuable in places where bells are impracticable because of the excessive bulk and weight which must be hung in existing belfries and church towers.

Measurement of yarn thickness and evenness

ACCORDING TO G. R. STANBURY of the Wool Industries Research Association, visual methods of wool comparison, although popular among practical men, are unreliable; for instance, a black yarn on a white background always appears to be much more uneven than a white yarn of similar quality on a black background.

For accurate work a photo-electric method has now been developed. A shadow cast by a short length of yarn affects the amount of light falling on a photoelectric cell and the resulting current is measured and recorded with the aid of a Lindemann electrometer. A constant-speed induction motor, through a 400-to-1 gear, drives both the rollers which draw the yarn across the slit placed before the cell, and also the recording camera. The results obtained agree quite well with those obtained by weighing yarn samples. The measurement of "twist" must still be done visually.

And now the electronic engineer

CUT COSTS

by the application of
Electronic Tubes
to your

Inspection Problems

FOR the first time we offer to Cleveland industry the services of a man who devotes himself exclusively to the production applications of the photo-electric tube and other electronic tubes. We can cut costs and simplify the inspection of any uniform product—whether the inspection be for size (within thousandths of inches), color, thickness, hardness, opacity or any similar quality. We not only give consulting-engineering service, but we design and build machinery, embodying electronic tubes, to solve your specific problems. A telephone call places this service at your disposal.

REX D. McDILL

913 Midland Bank Bldg. GLENVILLE 7689

This advertisement appearing in Cleveland publications has attracted much interest among production and plant men locally. Mr. McDill undertakes to make existing equipment more efficient.

Photocell starts moving exhibit

AT THE BUSINESS SHOW held in New York City this fall, the Royal Typewriter Company exhibited one of its automatic electric typewriters which continuously printed the same message. Ordinarily this machine was not in motion, but if a visitor came into the booth and reached for one of a pile of circulars on the table alongside the typewriter, the machine immediately began pounding away, being controlled by a photocell, the beam of which was interrupted by the visitor's hand reaching for the circular.

This arrangement of the photocell could be applied to many similar moving displays in exhibitions, shows, etc., as it has already been done in window displays.

Logs in paper mill counted by electric eye

In one of the plants of the International Paper Company it became important to find some way of counting the logs being ground up into pulp while the logs were on their way to the paper machine.

After trying various methods a photo-electric cell was resorted to with entire success, the logs being automatically counted as they flash by, carried by a rushing stream of water moving at high speed. A projector lamp throws a beam of light across the log raceway, and each log that sweeps by intercepts the beam and operates the counter.

MAGIC DOOR IN TORONTO RESTAURANT

When the waitress in the Diana Sweets restaurant, Bloor St., Toronto, Canada, crosses the light-beam in front of the kitchen door, the Stanley automatic opener swings the panels wide. There are two of these "magic doors" as shown, admitting traffic in both directions



DEVICES IN INDUSTRY + +

Cloth-dyeing machine with photoelectric reverser

A NEW FORM of electric "dye jig" built by Rice, Barton & Fales of Worcester, Mass., for textile mills, is equipped with a photocell for reversing the action of the machine so that it keeps the cloth material to be dyed moving continuously back and forth through the dye liquid.

A beam of light is projected across the underside of the beam roll, and as the roll of cloth gradually decreases in diameter, as it is paid out, it finally gets small enough to let the ray of light shine across the machine and strike the photo-cell which operates a relay, reversing the motion of the machine.

advantage in transoceanic radio communication, and its use in this connection is expected to eliminate difficulties from "fading," it having been found that when a short wave signal is weak at one point, it will nearly always be strong at another point only a few hundred feet away.

Another feature will be the use of the new "carbon recorder" method of transcribing the facsimile radio signals into a visible image. In this, a metal stylus moves over a sheet of carbon paper and makes the image visible on a sheet of paper. This is very much simpler than the usual laboratory method of facsimile reception and it accommodates itself to compact design.

+

Electric eye watches bowling-alley "foul line"

A PHOTOTUBE, installed by General Electric engineers on a Schenectady, N. Y., bowling alley makes it impossible for bowlers to step on or over the foul line without being immediately detected. A small beam of light is focused across the alley so close to the floor as to be intercepted by nothing except the player's toe, and this need slide across the foul line but a fraction of an inch to be detected and registered by a flashing red light. The throwing of the ball in no way interferes with the foul detector because of the speed with which the ball crosses the line. Under present arrangements, a referee sitting on a stool must keep his eyes constantly set on the foul line to watch for violations. His decisions often result in disputes as to whether a bowler's toe slipped over the line or not. The "electric eye," which does not even blink on an all night's vigil, eliminates all arguments.

Ships at sea get weather maps of whole ocean

NEW RADIO APPARATUS, designed for the reception in facsimile of weather maps of value to ships' officers and passengers, was tested in actual use on the SS. President Harding, during October.

Undoubtedly the most frequent question between ships at sea relates to the weather. The United States Weather Bureau collects scores of individual weather reports daily from ships in all parts of the Atlantic. This information is coordinated on a single map and a description of the map's important features is radio-telegraphed from shore stations for the information of all ships. Since it is difficult to describe a map with words, the Weather Bureau is able to impart only the most important weather conditions, and navigators are therefore necessarily deprived of the full data that the Bureau is prepared to give.

RCA engineers conducted similar facsimile tests a year ago, and although good results were obtained over distances of 3,000 miles, it was apparent that further development would be necessary to insure a reliability of operation comparable to the marine radio-telegraph service to which facsimile would be a supplement.

One of the most interesting innovations of the new equipment is that it will employ the diversity method of reception. Antennas fore and aft on the President Harding will serve as signal collectors for two separate super-heterodyne receivers, the outputs of which will be combined in a common amplifier. This diversity method, a development of RCA engineers, has for some time been employed to marked

Smoke recorder and truck-height indicator in Holland Tunnel

THE HOLLAND TUNNEL beneath the Hudson River between New York City and Jersey City is equipped with photonic cells which indicate the presence of excessive smoke or gas in the tube, automatically starting up the ventilating blowers.

Other installations of these Weston photo-sensitive cells safeguard the various tunnel entrances against trucks of such excessive height as would strike the ceiling if allowed to enter. Across each entry passage a beam of light is projected at the critical height, focussed on a photocell, which controls a relay and bell in the police booth where tickets are sold. If a truck entering in the line has any part projecting so high as to intercept this beam, the bell starts ringing in the police booth and continues ringing until reset, giving ample warning against selling the truck-driver a ticket until the clearance situation has been corrected. Tests made to determine the dependability of this photocell entrance guard, showed that it would start the bell ringing if a truck or car moving at 30 miles per hour, carried a projecting stick only one inch in diameter.

The photo-cell guard replaces a swinging board formerly installed, and arranged to close contacts when struck. Often the wind would blow this board out of place, causing it to miss trucks with projecting parts. The wind sometimes also caused the board to blow upwards and close the contacts, giving false bell indications. The board was also frequently injured by passing trucks and had to be replaced. The accurate photo-cell beam has eliminated all these troubles.



Trucks more than 12 ft. high approaching this Holland Tunnel entrance, intercept the 33-ft. beam controlling a photo-cell which rings a warning bell in the ticket-booth

Radio tubes used as photocells

By W. P. KOECHEL

KenRad Corporation
Owensboro, Kentucky

THIS article will describe methods whereby ordinary receiving tubes now on the market can be used as photoelectric cells. No special apparatus is required, and the tube alone functions as a cell.

The outstanding features of a tube used in this manner, are as follows: (a) its output response is in direct proportion to the *log* of the light intensity values impressed on it, (b) with 50 foot-candles it is possible to operate a cheap relay, directly in the plate circuit of the tube used as a photocell *without necessity for further amplification*, (c) it takes very little voltage to operate it, (d) due to its log relation characteristic, it can be made to give a direct reading on one meter range scale, of a ratio range of light intensity of 1:1000 or greater if desired.

All information and data given in this article are based on tests made on "stock model" tubes only. Tests on specially constructed tubes are being made and if found promising enough will be published later.

Conditions which affect the amount of photoelectric response from receiving tubes are as follows: (1) Type tube used; (2) grid connection; (3) filament voltage; (4) plate voltage; (5) "eye" of the tube.

To get best results it is apparently necessary to use

▼

VACUUM tubes of the types used in communication and other circuits are light sensitive if the grids are floating and if the cathode and anode voltages are properly adjusted. The data given in this article give an idea of the currents obtained and the sensitivity of commonly used tubes when employed as light-sensitive units.

▲

black plate tubes. Although a very few tubes with shiny plates will give photoelectric response, most of the ones tried by the author gave negative results. Of the many dozens of types tried, there were four types which gave excellent results (see Fig. 1). They are the 238, 239, 245 and 250, with the 245 leading for sensitivity and consistency. Out of about fifteen "stock model" 245 tubes tried, every one gave photoelectric response comparable to the data shown in this article.

It is also necessary that the tube be clear on top, so that light may have free entrance to the grid. For this

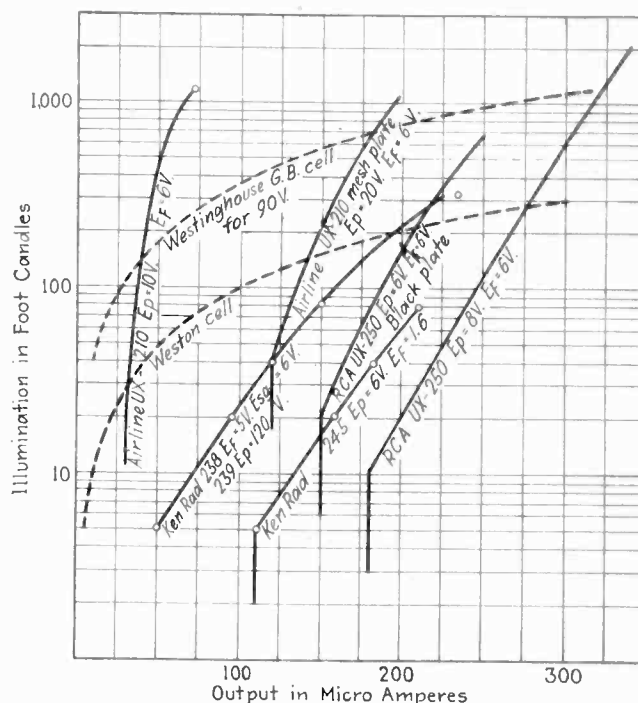

Fig. 1—Photoelectric response for various tubes, grid floating

reason tubes without mica top supports give best results. However, a type 210 with mesh plate gave good results with the light striking the plate from the side, probably because it was possible for the light to reach the grid through the mesh of the plate.

The second and most important condition for successful use as a photocell is to leave the grid of the tube "floating." If extreme sensitivity is desired, it is best to cut the grid pin off, close to the base of the tube, to prevent socket leakage.

The grid of any vacuum tube if left floating will assume a charge of approximately one volt negative. The exact value depends on the tube construction, and other element potentials.⁽¹⁾ With from four to twenty volts on the plate of a 245 this charge will be slightly over a volt.

This one volt acts as a bias, just as though a bias voltage were actually applied to the grid. Therefore if the plate voltage is adjusted almost to cut-off, with one volt bias, the same plate current reading will be obtained with the grid floating provided no light is shining on the tube. If the grid is illuminated the plate current reading will change. The relation of plate current change to light intensity is surprisingly consistent.

The apparent action of light is to make the grid emit electrons faster than it can accumulate them due to being in a free state or floating. Therefore it is extremely important that the grid be well insulated, for

¹See Morecroft 1st Ed. Page 487.

any small amount of base or socket leakage will cause some of the charge on the grid to leak off, even though no light is present. The ideal tube is apparently one which has a minimum of leakage and a maximum of grid back-emission. The physical composition of the grid and plate are also determining factors in photoelectric response, but have as yet not been investigated.

Filament and plate voltages

The third condition for maximum photoelectric response is that the filament voltage must be reduced. The amount it can be reduced is determined by two factors: the minimum reduction depends on the emissive qualities of the filament and the maximum voltage permissible depends on the amount of light given forth by the filament when lit. The filament voltage must be kept high enough to get the required plate current for maximum light, but kept low enough to minimize the effect of light from the filament. This filament value is best ascertained by actual experiment and will vary with different makes of tubes. Values given in Fig. 1 will serve as a rough indication of what to use.

The value of plate supply will be determined entirely by the purpose to which the tube is to be put. If used to operate a relay a source of 22 volts or higher should be used. If used as a light intensity indicator 4 to 10 volts will be sufficient, depending on the range of meter used to indicate plate current and the type of tube used. Experiments to date show that it is necessary to use d.c. plate voltage supply. It will be noted from Fig. 2 that the output response is very critical to small changes in plate voltage. Therefore it is important to have a constant source of supply for this purpose.

The "eye" of the cell

From all data gathered so far the "eye" of the tube is the grid and the light rays must therefore enter the tube in such a way as to impinge on the grid. A beam of light focused on the outside of the plate has no effect at all. Tests made on various tubes without grids also gave negative results.

Other tests made were to focus parallel beams of light in such a way that they impinged on the grid only, using for this purpose tubes with protruding grids. These tests gave very positive results. Although the

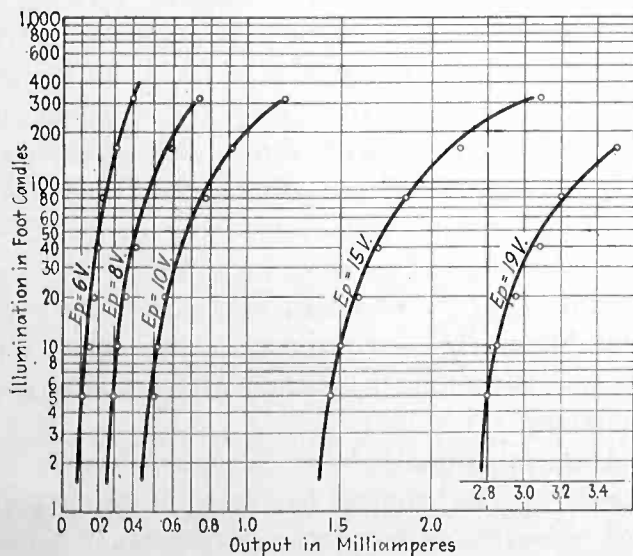

Fig. 2—Response curves of UX-245, filament voltage 1.5, grid floating

foregoing is not submitted as conclusive evidence that the grid is the light active element in the tube, nevertheless it points in that direction. Further tests are being made to check on this point.

Initial tests on various tubes indicated that body capacity effects were very pronounced, and that for purposes of light response measurements, it was necessary to shield the tube, grounding this shield to the filament of the tube under test. The shield used consisted of a piece of brass tubing a little longer than the tube. Under these conditions the plate current of various tubes was measured for various values of light intensity impressed on the grid. The results are shown in Fig. 1.

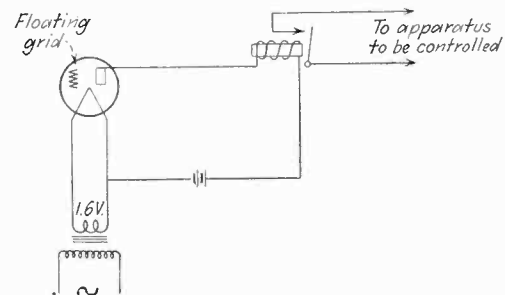

Fig. 3—Circuit for using UX-245 as photocell

It is at once obvious that response in plate current is not a linear relationship to light intensity values. Although varying somewhat for various tubes the approximate relation is $I_p = \epsilon K I^p$, where I equals light intensity, I_p plate current and K a constant. The conventional expression for sensitivity of a photocell is I/F , where I is the output response in $\mu a.$ and F light flux in lumens, instead of in foot-candles as shown in accompanying data. The reason for not using lumen values is that it is necessary to know the active area of the light responsive element, and which is unknown in these tubes. Therefore all values have been given in foot-candles as measured from the edge of the plate.

It is possible to use the tube "as is" for various applications, where it is not necessary to detect small changes in light. When used for operating a relay the tube is connected as shown in Fig. 3. This relay should be capable of operating on from 1 to 10 ma. The plate voltage will of course have to be high enough to give the required I_p for operating the relay, with the required light shining on the tube. The expected change in plate current can be predicted from the curves in Fig. 2.

For example: A Western Electric type B-40 relay (400 ohms) can be adjusted to operate on 1.5. Therefore, if 15 volts plate supply is used, the plate current will be about 1.4 ma. with the tube dark. If now a source of 50 foot-candles or higher illumination is caused to fall on the grid of the tube, the plate current will rise to 1.7 ma., and operate the relay. The same end can be accomplished by using a higher plate voltage, if a less sensitive relay is used.

All of the data given in this article applies only to the types of tubes shown as tested. It is possible that other makes of tubes or specially constructed tubes will give entirely different results. Therefore the curve data given here should be accepted only as a rough indication of the possibilities of photoelectric response from ordinary receiving tubes.

electronics

McGraw-Hill Publishing Company, Inc.
330 West 42d Street
New York City

O. H. CALDWELL, *Editor*

Volume V — DECEMBER, 1932 — Number 6

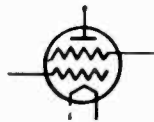

The tube situation— both sides

DURING the past year the number of receiving-tube types has nearly doubled, increasing the burden carried by the tube manufacturer and the dealer. Many of the new items have been worth while; they have been widely adopted by many set companies displacing older tubes long in service. Some of the new tubes, however, are so similar to others already on the market there seems little justification for their introduction.

Many attempts have been made to get order into the process of developing and merchandising new tubes. The continual demand from set executives and engineers for trick tubes for a special sales effort has been universally deplored, even if almost universally practised.

These attempts at cooperation have been but partially successful. At a recent meeting of executives of radio tube and radio set manufacturers, eighteen manufacturers believed that the industry would be benefited by a cooperative effort to limit the number of new tubes, and to work out other problems incident to rapid development. One manufacturer disagreed. The meeting therefore failed in its purpose to achieve cooperation.

Electronics views with disfavor any attempt by any method to limit the research or initiative of any tube maker, small or large. It believes that men's minds cannot be legislated out of the habit of invention. But it also believes in cooperative efforts. In this particular case the mere weight of numbers may not indicate that cooperation is the better course but undoubtedly there is a line of action that will satisfy the individualist and at the same time keep the number of new tube types from getting out of control.

The human voice as control impulse

THE electronic tube opens up interesting possibilities in controlling machinery by the human voice. We have long been accustomed to the handwritten signature as the basis of world-wide credit. Now we have developed to the point where we are using fingerprints even in commercial work, as a means of personal identification. Already, this is being done with Postal Savings accounts by the United States Government.

But we have a much more easily handled means through identification by the human voice.

For instance, identification in connection with a cash register by means of a voice impression upon a tube and associated mechanism, or upon a retail door lock mechanism to identify the person opening the store, is well within the range of possibility. The control of certain types of fuel could be easily applied according to the noise the fuel makes in issuing from the burners. The movements of parts can be controlled according to the noises of the parts or according to the variation in volume of a predetermined sound such as a whistle controlled by the movements of those parts.



The growing army of radio amateurs

OF both interest and significance is the increase in the number of licensed radio amateurs reported by William D. Terrell, director of radio for the Department of Commerce. From 22,739 in 1931, to 30,374 in 1932, an increase of 7,635 is shown for the year, or about one-third. Contrasted with the 16,000 amateurs in 1928, the army of the amateurs is now nearly doubled. From these ranks are recruited the experimenters and inventors who keep radio forging ahead. In themselves they constitute a considerable market for radio sales, for the modern amateur is no longer satisfied with crude haywire equipment.

Amateur signals have become sharper and steadier, crystal control has been largely popularized, precision of frequency setting has improved, until in all respects many amateurs perform to a standard characterizing the professional services.

New York harbor light is PE-controlled

EVERY ship which comes up New York Harbor after nightfall follows the course directed by the famous Elm Tree range light, which is now photo-electrically controlled so as to be switched on automatically at dusk.

Eventually it is expected that all of the navigation lights around New York Harbor will be automatically controlled by photo-cells, without human operation. The tests so far have shown the full dependability of photo-electric control, even under such rigorous requirements as that of safeguarding ship traffic in the busiest harbor of the United States.

★ ★

May widen broadcast band to 460 kc.—With general ratification of the findings of the International Radio Conference at Madrid now dispaired of, it seems likely that a North American conference will have to be called, attended by representatives of the United States, Canada, Mexico, and Cuba. With the pressure on the broadcast band for more channels, the present proposal is to utilize channels at 10-kc. intervals up to 460 kc. for broadcasting, leaving a 30-kc. guard band around the marine calling wave at 500 kc. (600 m.). Already Canada is operating the Windsor, Ont., station on 540 kc., and has authorized other stations on 520 and 530 kc.

RMA "certified radio sets"—Receiving sets offered for sale by members of the Radio Manufacturers' Association are to bear a seal or label certifying that they fulfill the following standards: Submission to Underwriters Laboratories for approval. Tuning range covers the entire U. S.-Canadian broadcast band. Sets are non-interfering up to RMA standard. Sets meet approved requirements of tone quality and performance. Approvals will be made by the R.M.A. Engineering Institute, operated under the supervision of Chairman Hutchinson of the Association's Engineering Division.

Thomas A. Edison's radio tube of 1883—On November 21, 1932, just forty-nine years after Thomas A. Edison applied for a patent on a construction of his incandescent lamp which resulted in particles of electricity leaving the hot filament and collecting on a plate enclosed in the vacuum, one of these Edison-effect lamps was employed by Dr. Clayton H. Sharp and his associates of the Electrical Testing Laboratories, New York, to serve as the detector tube in a radio set. Through this "great grandfather" of all radio tubes, the radio audience of the NBC Blue Network was able to listen to Mr. Edison's favorite air, "I'll Take You Home Again, Cathleen," reproduced with remarkable fidelity.

Broadcasters discuss copyrights, channels—The convention of the National Association of Broadcasters, held at St. Louis, Mo., Nov. 14-16, was chiefly occupied with discussion of copyright charges, and the increasing rates imposed by the American Society of Authors, Composers and Publishers. Oswald F. Schuette was authorized to negotiate for lower license fees. Acting-chairman Harold A. Lafount, of the Federal Radio Commission, who appeared before the convention, predicted the early abandonment of exclusive channels by which stations now serve large areas of rural and mountain territory, under the pressure of political demands for putting two or more stations on the same channel, on opposite coasts. Alfred J. McCosker was elected president of the broadcasters' association.

Dr. Hull president I.R.E.—The Institute of Radio Engineers announces the election of Dr. Lewis M. Hull, Radio Frequency Laboratories, Boonton, N. J., as president for 1933. The vice-president for next year will be Dr. Jonathan Zenneck of Muenchen, Germany. Five new directors have been elected. Three of these to serve for three years each are R. A. Heising of the Bell Telephone Laboratories, F. A. Kolster of International Communications Laboratories, and H. M. Turner, of Yale University. C. W. Horn of the National Broadcasting Company will serve for two years and M. C. Batsel of RCA Victor, Inc., has been elected for a one year term.

No radio trade show in 1933—Officials of the Radio Manufacturers' Association have announced that no radio trade show will be held next season, interrupting a sequence of several years' standing. It is believed that the experiment of omitting the trade show this season will be in line with the economics of the present situation, and that instead of bringing out new models at the time of the show, set makers will have more time to design their models for the coming season. Based on 1933 experience, the R.M.A. directors will then consider the holding of future trade shows.

Nashville's 878-ft. antenna goes into service—The new 50-kw. transmitter of WSM, the National Life & Accident Company's station at Nashville, Tenn., is equipped with the 878-ft. tower pictured on the front cover of this issue, the tallest such mast ever erected. The steelwork weighs 150 tons, and is carried on huge thrust insulators which have been tested to 3,000,000 lb. load, according to J. H. DeWitt, Jr., chief engineer. Each of the eight guy wires is stretched to a tension of 55,000 lb. and is tied to a 54-ton concrete guy anchor. Seven insulators in each guy break up any radiation characteristics. WSM's new transmitter went on the air, Nov. 12.

INSULATOR CARRYING 150-TON 878-FT. ANTENNA OF WSM (See front cover)

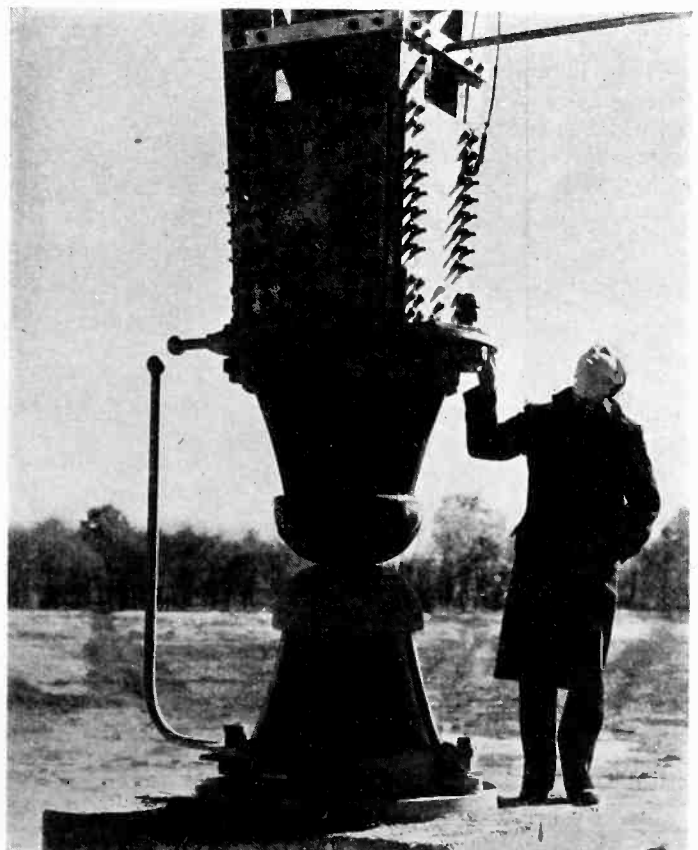

The tallest radio antenna ever installed, reaching up well among the highest structures of the world, is WSM's new vertical radiator. The tower weighs 150 tons, but the insulator unit has been tested to carry 1,500 tons.

REVIEW OF ELECTRONIC LITERATURE

HERE AND ABROAD

Eighth German physical-mathematical session

[KAGAN] Brief summary of papers presented at Bad Nauheim, with fuller details of the work of Meyer and Schüler of the Heinrich Hertz Institute on recording by steel tape, which is stated to have now attained a satisfactory standard "for most purposes," with frequencies up to 5,000 cycles and a low noise background. — *Funk, Berlin, October 21, 1932.*

Radio patents

[SCHR] *Volume Control.* French 715062 in which two variable resistances are mounted on a common axis, one increasing the negative polarisation of the amplifier grid(s) and the second forming a shunt of decreasing resistance to the antenna coil, but not commencing to function until the action of the first coil is insufficient to prevent overloading.

Combination tones, modulation, and non-linear distortion

[KHUNER.] Exceptionally clear elementary discussion of the so-called non-linear distortion from the point of view of the Helmholtz theory of combination tones. — *Radio Amateur, Vienna, August, 1932.*

Interference filtering

French 714577. By introducing ohmic resistance into the circuit of a wave-trap, etc., its effectiveness at the carrier frequency of the unwanted station is decreased, but its effect as regards the side-

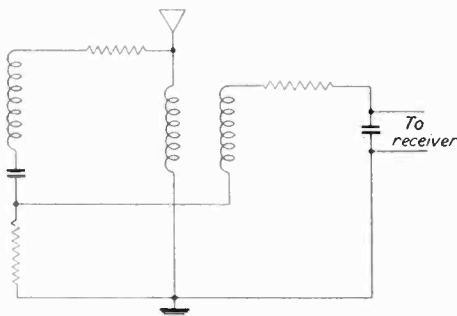

bands is increased. To compensate for the first loss the interfering signals are fed in opposed phases to the receiving circuit, as in the system shown. — *Funktechnische Monatshefte, Berlin, October 1932.*

New electronic instrument

[SARAGA] Communication from the Heinrich Hertz Institute. A photo-cell is used to alter the grid polarisation of a triode, and hence its internal resistance, this changing the frequency of the neon lamp circuit shown and thus controlling the pitch. The photocell is

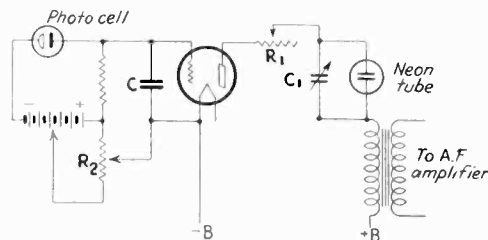

illuminated by diffused artificial light through a V-shaped slit, over which the player's hand moves: the more the light allowed to pass, the lower the note produced. C_1 of about $1,000 \mu\mu F.$, serves to suppress the alternating-current note due to the source of light being fed from the mains. R_1 and C_1 fix the highest note obtainable, R_2 the lowest. A formant-producing circuit can be added as in the Trautonium. Suggestions for modifications and improvements of the instrument are given. — *Funktechnische Monatshefte, Berlin, October 1932.*

Room errors in loud-speaker tests

[EDWARD W. KELLOGG] R.C.A. Victor Company. Since direct and reflected sounds are not simply added by the ears, but each serves to convey its own impression, no single curve of loud-speaker output can show how the loud-speaker will sound in a given room. At least two curves, the curve of total radiation, and more important and more generally used, the curve of the sound pressure directly in front of the loud-speaker, are required. As it is difficult to prevent reflections from reaching the measuring microphone, it is desirable to calculate the ratio of reflected to direct sound. Methods of estimating the first reflections and multiplying reflected sounds are discussed. In a room 10 ft. x 15 ft. x 25 ft. with an average absorption coefficient of 0.20 or a reverberation period of 0.6 sec. reflected and reverberant sound may amount at 15 feet from the source to over 36 times that of the direct sound. — *Journal Acoustical Society, July-Sept. 1932.*

Low voltage cathode-ray tube

[G. DOBKE] Research Lab. German Gen. El. Co. The cathode is a small black body cavity heated by a helix of tungsten wire. With this construction the emission remains constant for over 3,000 hours. Mercury vapor is used for concentrating the beam in addition to a Wehnelt cylinder. At the normal operating potential of 300 volts the sensitivity is about 1 mm. per volt. — *Zeitschr. techn. Physik September 1932.*

The spectrum of airplane noises

[F. EISNER, H. REHM AND H. SCHUCHMANN] Research Institute for Air Navigation. A tone of variable pitch and band pass filters having a width of 100 cycles are used. The ribbon microphone is placed under the left-hand wing. The records obtained show that all the stronger components lie below 1,000 cycles per sec. This is the reason why European practice has turned to code and long waves modulated with a frequency of 1,000 cycles as a means of communication between plane and ground, this method allowing work with field strengths of a few microvolts. Telephone communication was found to require 200-600 μ -volts. — *Elektrische Nachrichtentechnik, September, 1932. E.T.Z. September, 1932.*

Photocell response to sudden illumination

[P. FOURMARIER] Potassium and cesium cells containing neon, argon or helium were suddenly (within 10 microseconds) exposed to a brightly illuminated slit. The photoelectric current was found to increase in two steps, first along a rapid slope and then more gradually whatever the cathode used. When by applying high potentials the amplification of the cell is made larger than four or five, the lag produced by the second portion of the curve increases from a few microseconds to a few milliseconds (pressure a few tenths mm. mercury). The author thinks that the lag is due to the time required for ionization by positive ions; it might also be due to the establishment of space charges. — *Revue generale de l'electricite, September 24, 1932.*

Electric discharges in gases

[IRVING LANGMUIR] Research Laboratory General Electric Company, Schenectady. A general account of electric discharge at low pressures, such as exist in thyratrons and mercury vapor rectifiers was presented to the International Electrical Congress, Paris 1932. When positive ions only of charge $+e$ are produced uniformly throughout the space between two parallel plain metal plates, set " a " cm. apart, S ions being produced per unit volume per second then as in the case of the pure electrons discharge the current, I , is given by a $3/2$ power law. When I happens to be equal to Se_a , the current density is 2.865 times that obtained when all the positive ions are given off by one electrode instead of being produced throughout the volume. When the rate S is larger (half a microamp. in the case of mercury vapor at room temperature and $a = 5$ cm.) a positive space charge is produced and the distribution of charges is no longer uniform. Actually, however, together with positive ions, electrons are set free and are drawn into the positively charged region until the space charge is reduced to zero. A division into electrode layers or sheaths and a field free space or plasma (positive column) results. At low pressures the electrons set free in the column by swift electrons from the electrode layers have considerable random velocity, and a random current of electrons adds itself to the drift or field current. The walls become negatively charged. It is asserted that these features explain qualitatively the most important characteristics of low pressure discharges in tubes.—*Journal Franklin Institute, September, 1932.*

Anti-fading antennas

[NOACK] After a general discussion of the forms which such antennas may take, special attention is devoted to that recently erected at Breslau, where an auxiliary radiation in opposing phase to the main one is produced in such a way as practically to suppress the radiation between 67 and 90 degrees from the horizontal plane. The antenna is a vertical rod 140 meters high (for a wave-length of 325 meters) with a capacity top consisting of a metal ring 14 meters in diameter, of ten-centimeter copper tubing, horizontal and having the antenna as center. The antenna tower must be wooden, as the vertical rod goes up through the center of it. Results are excellent: at 80 Km. distance the fading observed is in the ratio $\frac{1}{2}$ maximum (rarely over $1/1.2$) as compared with $1/30$ with the normal antenna: at 160 Km. $1/12$ (average $\frac{1}{3}$) as against $1/50$. Nevertheless, good reports of distance reception have been received, e.g. from Greece and Finland.—*Radio Amateur, Vienna, November 1932.*

Radio in mines

[NOACK] Description of the writer's experiments with radio-telephony to and from the cage during its descent, and also with the galleries, using directed waves along metallic objects (piping, wire ropes, etc.). Waves of about 30 meters gave very good results, being especially preferable to longer waves in cases where these metallic conductors were broken, gaps of 10 and 20 meters being readily bridged.—*Funk, Berlin, October 14, 1932.*

French shows 1932

[PICARD] Impartial résumé: some points of special interest are—the progress of tone-control, now fitted to nearly all receivers; criticism of American fading-compensators as being too incomplete in their action and contrasting unfavorably with French methods (especially that of Chrétien); unpopularity of radio-gramophones with French makers and public; decrease of prices since last year, but chiefly as regards the larger sets; higher proportion of mains-fed receivers at the shows than anywhere else in the world, and a query as to how far the abandonment of battery receivers is desirable; amusing reversal of fashions—in America a few years ago everyone was for tuned r.f., in France for the superheterodyne, now America solid for supers and in France a strong current in favor of tuned r.f.; French tubes better than American (higher μ , higher mutual conductance) although French makers now also produce American types; practical disappearance of the double-grid frequency-changer in French superheterodynes in favor of two separate triodes, although the "Strobodine" principle with one triode only is still used, and one maker uses a triple-grid tube as frequency-changer. A very useful table of the principal receivers with characteristics and prices is attached.—*RAD, Paris, October 1932.*

Electronic microscope

AS REPORTED IN ELECTRONICS Digests, November, 1931, coils act on electron streams somewhat like lenses on light rays, and may be used for magnifying the image of a surface which emits electrons. Now, E. Brueche and H. Johannson, German General Electric Company, show that magnifications about 15-fold of slits traversed by electrons can be obtained in this way. The same result may also be achieved with the aid of a second method, by using small charged metal diaphragms. The lines of force in the neighborhood of the opening of the diaphragm are curved in such a way that they cause the electrons to form an enlarged picture of the most active spots from which they issue, on a screen or plate placed at a suitable distance. The figures are taken from *Naturwissenschaften, May, 1932.*

ELECTRONS WITH BIRTH CERTIFICATES

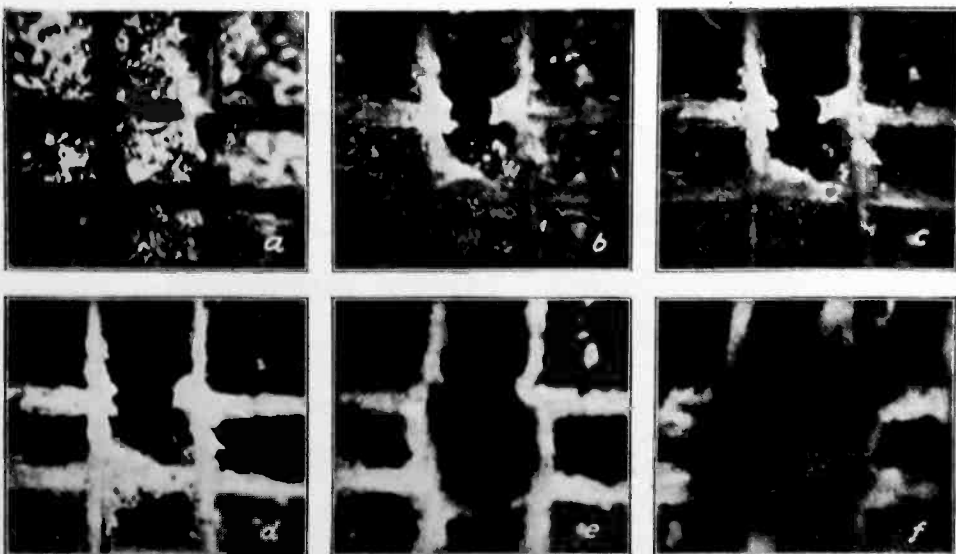

The electrons sent out from a filament and "focussed" by means of the diaphragms throw an enlarged picture of the oxide coated filament upon the screen. For reference purposes a network of scratches has been cut into the filament. The pictures *a* to *f* show the effect of overheating the filament until the activity is destroyed

Home recording

[NESPER] Exceptionally full article on the various materials available and processes used in preparing discs for home gramophone recording, with a historical summary.—*Radio B.F.f.A., Stuttgart, October 1932.*

Chrom-selenium photo-voltaic cells

[COLIN G. FINK and D. K. ALPERN] Columbia University. Chrom-selenium films obtained by electro-deposition are more uniform and stable than selenium plates. The bath used contains selenious acid. The dry cell consists of a photo-active layer on lead covered by a semi-transparent metal film on its outer surface and is similar in appearance to the Schottky obverse cell (or front detector wall cell, see *Electronics*, October, 1932). The sensitivity is from 150 (commercial) to 500 (laboratory type) micro amp. per lumen (as against 120 for the photonic cell, 500 for the cuprous oxide reverse and 5,000 micro amps. of the Schottky cuprous oxide obverse cell, 300 microamp. of the selenium obverse cell.—*Trans. Electrochemical Society*, preprint September 1932.

Ferrocart coils

[HANS VOGT] 10 Garystrasse, Berlin. Miniature tuning coils rivaling in efficiencies those of the air-core type on 3-inch forms may be built with a core consisting of minute particles of a high-grade magnetic material scattered in a solid insulator (ferrocart). Steep-resonance curves are obtained.—*Wireless World*, September 16, 1932.

List of British vacuum tubes

A GUIDE to some 430 different tubes now on the British market. In contrast with the list of American tubes in October *Electronics*, only tubes being intended for radio sets are given; 31 variable- μ 's, 5 screen-grids, 51 special tubes, 36 indirectly heated a.c. and 8 indirectly heated d.c. tubes, 125 output tubes, that is tubes with a.c. resistance less than 7,000 ohms, 29 being indirectly heated tubes, 55 pentodes, 63 rectifiers and 7 Westinghouse metal rectifiers. The tubes are the products of about 16 manufacturers. It was decided to omit from the list four and six-volt battery tubes, etc., in order to set an example in the endeavor to reduce the unnecessarily large total.—*The Wireless World*, November 11, 1932.

Inventions

FRENCH 729957 FOR A new type of lamp for recording and television, with a grid ("supplementary anode") between the filament and the anode proper, this being an opaque cone with an insulating cone between it and the filament to limit the area of luminosity, and containing mercury vapor.—RAD, Paris, October 1932. Note also the full list of French patents recently issued, titles only, without further details.

Screen-grid frequency changer

[E. L. C. WHITE] The local oscillation is fed into the anode circuit (instead of, as usual, into the grid circuit) of the first detector, or frequency changer, so as to have no interaction between the tuning of the grid circuit and of the local oscillator, and no radiation from the grid. For good functioning I_p-E_p and I_p-E_g curves must be nearly straight and diverge with increasing plate voltage. This is the case in screen-grid tubes when the plate voltage is somewhat below the screen voltage. Increase and decrease of plate current occurs at the difference of frequency between the two signals, being given by the product $f(v_p)$ by $f(v_g)$.—*The Wireless Engineer*, November 1932.

Practical elimination of night time fading

[H. HARBICH and W. HAHNEMANN] German Post office. By using high antennas or antenna polygons it is possible to reduce the sky waves of between 45 deg. and 90 deg. with the ground. Experiments at 300 m. gave good results when three vertical antennas, about 30 m. long and spaced 100 m. apart ($\frac{1}{3}$ wave-length) were fed from the same sender, the current in the middle antenna being twice as strong as that in each of the outer antennas and in opposite phase. In order to provide the same service along different directions, six antennas are arranged in a polygon around a central antenna which is in phase opposition and carries the same current as all the other antennas taken together. Polygonal antennas are desirable for high powered stations only where the field intensity amounts to 1 mV/m at 50 to 100 miles from the sender.—*Elektrische Nachrichtentechnik*, October (published November) 1932.

Eight-meter communication; France to Corsica (120 miles)

[E. PICAULT] chief engineer, French Post Office. After several years' study dating back to 1929, wireless telephone communication has now been established between Nice (Southern France) and Calvi (Corsica) using 120 watts on a wave-length of 7.6 m. in one and 8.2 m. in the other direction. As these waves travel in straight lines it was found necessary to place one end of the "line" at 500 m. altitude and the island station at 200 m. The straight line connecting these two points passes in part through the sea. The fees are the same as those in force for stations on land 120 miles distant. A horizontal antenna was used as it seemed to reduce interference from the many motor boats.—*Revue generale de l'electricite*, October 1932.

Broadcasting on 7.85 meters at Amsterdam

[P. J. NORDLOHNE] Res. Lab. Philips, Eindhoven. From November 1930 to November 1931 the Philips' Incandescent Lampworks Laboratory has made tests on 7.85 meter in order to find out whether 300 watts would be sufficient for local broadcasting in a city the size of Amsterdam, of the order of 20 sq. miles. For distances over one mile, superheterodyne short wave converters had to be used, and it took several minutes, in the case of indirectly heated tubes $\frac{1}{4}$ hour, until the frequency settled to a constant value. The field intensity is much lower in narrow lanes than in wide thoroughfares, for each 1,000 meter from the transmitter the intensity falls to 1/10. Interference from passing automobiles was troublesome. Apart from this the results are considered to be promising.—*Hochfrequenztechnik and Elektroakustik*, August 1932.

NOBEL PRIZE WINNER—1932



Dr. Irving Langmuir, widely honored for his research on electrons, sailed from New York, November 30, to receive the Nobel prize for Chemistry. With Dr. Langmuir above is Dr. A. H. Hall

+ NEW PRODUCTS

THE MANUFACTURERS OFFER

100,000-ohm wire-wound controls

RECEIVING-SET DESIGN requiring both high-resistance value and noiseless operation in a volume control encased in standard size, is now possible with a new unit offered by the Clarostat Manufacturing Company, 287 N. Sixth St., Brooklyn, N. Y. The element is wound on a standard-size Bakelite strip, and is contained in a dust-proof molded case. Contact is maintained by a long-lived phosphor-bronze shoe. The control can be furnished with or without switch attachments, in any taper, in values up to 100,000 ohms.—*Electronics, December, 1932.*

Attenuators with constant impedance

ELECTRAD, INC., 173 Varick St., New York City, calls attention to its L and T pad attenuators. Approximately constant impedance can be obtained by using a dual control consisting of a series and a shunt resistor. With this arrangement, the impedance looking from the source to the sink is always constant. Electrad constant-impedance "T" pad controls are useful for the volume control of microphones, electrical phonographs, talking picture amplifiers and other sound amplifying and distribution systems. Constant impedance is maintained throughout the adjustment of knob.

The line impedance in ohms ranges from 15 to 5,000 ohms, and the list prices of all sizes are L pad \$3, T pad \$5.—*Electronics, December, 1932.*

Regulator with screw-base

WHEREAS radio tubes amplify voltage variations, Amperite regulators decrease line voltage variations and therefore have what may be termed a "de-amplification" factor. Instead of 15, obtained by the old series, the new series will absorb 25 times as much voltage as an ordinary wire resistance.

The wattage consumption of radio sets average 0.1 amperes per tube. Thus: A 7-tube set draws 0.7 amperes and therefore Amperite 7-A-5 is recommended. A 9-tube set draws 0.9 amperes and Amperite 9-A-5 is recommended, etc. Exceptions to the above rule are sets using the 250 tubes.

Railroads are using Amperites for signal lights; electric companies for motor generators; automobile companies for efficiency meters, etc., according to the Amperite Corporation, 561 Broadway, New York City.—*Electronics, December, 1932.*

Ratchet-type relay

STRUTHERS DUNN, INC., 139 N. Juniper St., Philadelphia, Pa., offers a new ratchet-type relay sometimes referred to as a sequence relay, or step-by-step relay. The energizing of the coil moves the pawl, engaging a ratchet, which moves a cam or cams to open or close the contacts.

By a minor adjustment of the cams moving the contacts, together with a method of connecting the moving con-

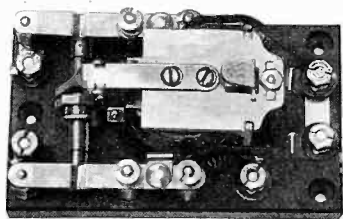

tacts together, these relays can be made single pole, double break; double pole, single break; or single pole, single break, double throw.

The unit is compact, and is mounted on base 5 in. by 3 in. The contacts are rated to carry and break 20 amp. at 110 volts a.c. non-inductive load or $\frac{1}{4}$ hp. motor load.—*Electronics, December, 1932.*

Pot galvanometer

THE CAMBRIDGE INSTRUMENT COMPANY, INC., 3732 Grand Central Terminal Building, New York City, has designed its Cambridge pot galvanometer as a general-use instrument for laboratory applications as well as educational purposes, the instrument being provided with a pointer scale and a reflecting mirror. It is of the moving-coil type, the coil carrying an 8-mm.-diameter plane mirror; the window in the case is a lens with a one-meter focus.

The galvanometer is furnished only with a coil of 50 ohms resistance, this giving a sensitivity of 30-0-30 microamperes on the pointer scale. At a mirror-scale distance of one meter, one microampere gives a deflection of 12 mm.—*Electronics, December, 1932.*

Special iron for vacuum-tube electrodes

"SVEA METAL" is the name of a new pure-iron product being imported and marketed by the Swedish Iron and Steel Corporation, 17 Battery Place, New York City, for use in radio tubes and other electronic containers, where it replaces nickel at about one-half the cost. By the reduction of impurities, the elimination of gas, and special treatment of the material, the resulting product is declared to have many superior properties for use in electronic tubes as electrodes, plates, getter cups, screens, lead-ins, support wires, etc. Already a number of important radio-tube makers are experimenting with Svea metal.

Among the advantages possessed by Svea metal, in comparison with nickel, are the reduced bombardment required (about 50 per cent); longer life of the tube due to less ionization by collision; higher heat resistance by about 140 degrees. lighter weight and greater corresponding surface; close approach to glass in co-efficient of expansion; easily weldable to nickel or copper; and availability to be rolled, worked or processed in any way. Svea metal responds well to plating with nickel, copper, cadmium or other metals, and can be finished bright or dull, matte or brilliant. Svea metal has a high resistance to oxydization. Its low "sputter factor," about 5 per cent (compared with gold, silver and lead at 75 to 100), makes it a valuable electrode material for neon tubes, television tubes, etc. Among its properties defined by its producers are:

Electrical resistance, microhms per cm. cube	10.2
Melting point, Centigrade	1535
Specific heat	1150
Watt loss per kilogram at 60 cycles	0.070
Tensile strength, pounds per sq. inch	44,000
Weight per foot, 0.005 x 6-in. strip	0.102
Specific gravity	7.86
Permeability, Initial	180

—*Electronics, December, 1932.*

Transmitting condensers

TRANSMITTING CONDENSERS in capacities from 30 to 500 $\mu\text{f.}$ designed for potentials from 1,000 to 6,500 volts, have been developed by the Hammarlund Manufacturing Company, 424 West 33rd St., New York City.

Heavy cast aluminum end-plates shield the condenser thoroughly. Four heavy aluminum posts strongly tie these plates

together and this construction is further reinforced by Isolantite cross bars. Bearings of the best quality and workmanship assure smooth operation and long life. Plates are securely held by large diameter spacers and by staking. Insulators of Isolantite provide for lowest losses and highest operating efficiency at all voltages and frequencies and under all conditions of temperature and humidity.—*Electronics, December, 1932.*

Tube checking adapter

THE ALDEN PRODUCTS COMPANY, 715 Center St., Brockton, Mass., has just put on the market its new NA-ALD 50 XYL tube checking adapter.

This new adapter permits existing tube checkers to handle any of the 40 new tube types. It contains the proper resistance network to protect sensitive diodes from excessive current, as well as to safeguard delicate instrument movements from the high current of mercury-vapor rectifiers. List price, \$6.—*Electronics, December, 1932.*

Dry storage battery

A LIQUID-BOUND non-spill dry storage battery to be known as the "Rechargit" is being manufactured by N. D. Sturges, Inc. and sold by Lee Skipwith & Co., Inc., 369 Lexington Ave., New York City.

This battery has the usual lead-sulphuric acid couple used in regular storage batteries, but it is made liquid-bound through the use of a special patented insulation which holds a quantity of electrolyte in absorption.

It is claimed that this battery has all the advantages of capacity, efficiency, ruggedness and long life of a good storage battery, combined with the cleanliness, portability and freedom from injurious liquids of the dry primary battery.—*Electronics, December, 1932.*

B-power source

THE EMERSON ELECTRIC MANUFACTURING COMPANY, 2018 Washington Avenue, St. Louis, Mo., has developed a new light-weight self-contained B power unit for radios in automobiles, police cars, airplanes, and motor boats. The outfit operates from a standard 6-volt battery and delivers 140 volts direct-current. No current is taken from the A battery except when the radio set is in operation. Its consumption is then only two amperes, about the equivalent of a small parking lamp. The unit is substantially built of formed steel, and is fully enclosed for protection from dust, dirt and moisture. Noise and interference are eliminated by the methods of mounting, enclosing and shielding moving parts.—*Electronics, December, 1932.*

Fusible jack for multirange meters

A NEW FUSIBLE JACK has been designed, enabling the user to employ the correct size of fuse for each scale reading on multirange meters and still be able to shift readily from one range to another. The fusible jack is secured under the binding post of the instrument, and the fuse is enclosed within the bakelite barrel which is merely unscrewed to make fuse renewals.

The fuses used in this mounting are Instrument Littelfuses and come in

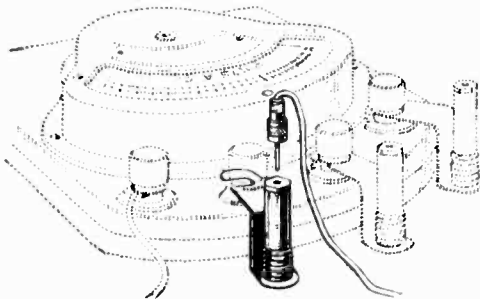

1/100, $\frac{1}{32}$, $\frac{1}{16}$, $\frac{1}{8}$, $\frac{1}{4}$, $\frac{1}{2}$, 1, and 2 amperes capacity. On account of their quick acting characteristics they afford protection to even the most delicate instruments.

These fuses and mountings are manufactured by the Littelfuse Laboratories, 1772 Wilson Ave., Chicago, Ill.—*Electronics, December, 1932.*

A.C. welder for thin-gauge materials

THE WESTINGHOUSE 100-AMPERE FLEXARC a.c. welder is rated at 220-440 volts, 50-60 cycles, single phase, with current range of 4 to 125 amperes, so that this welder meets the great demand for the economical arc welding of thin-gauge material such as that encountered in the manufacture of metal furniture, sheet-steel cabinets and containers, in aircraft fabrication work, job and garage repair work and in the fabrication and erection of ventilating systems and materials handling equipment of many kinds.—*Electronics, December, 1932.*

Midget relay

THE WARD LEONARD ELECTRIC Co., Mount Vernon, N. Y., announces a new design of midget magnetic relays for remote control. A new moulded base provides more rigid mounting of contacts and binding posts. A newly designed armature improves the magnetic circuit and alignment of contacts with reduced energy consumption.

These relays can be furnished in single and double pole, single and double throw and various arrangements of contacts and terminal connections, for a.c. and d.c. up to 110 volts.—*Electronics, December, 1932.*

Radio plug

AN ADDITION to the line of radio products of the Cinch Manufacturing Corporation, 2335 W. VanBuren Street, Chicago, is a new radio plug which provides positive, dependable contact in both male and female types. The plugs are available in 4, 5 and 6-prong types. Easy assembling is provided by a neat, positive locking cap of moulded bakelite. Ample room for soldering is likewise provided. The female plugs are equipped with standard Cinch "floating contacts."—*Electronics, December, 1932.*

Terminal blocks

THE STATES COMPANY, New Park Ave., Hartford, Conn., announces a new idea in terminal blocks. The new block will do all that the old-style terminal boards and isolation switches can—plus providing a ready means for cutting instruments into the circuit. "Connect the instrument and drop the link—that's all," explain the makers who state for the device the following advantages:

1. To cut an indicating instrument or artificial load into circuit, simply attach the leads to both terminals and drop the link.

2. Link clearly indicates "closed" or "open" position.

3. Positive contact.

4. Individual blocks may be easily replaced in case of accident without disturbing rest of blocks or wires.

The device occupies little space.—*Electronics—December, 1932.*

Reflection meter

THE AMERICAN PHOTO ELECTRIC COMPANY, 215 Third Ave., New York City, has developed a reflection meter designed to compare and measure the total reflection factors of similar opaque materials. The instrument illuminates an area of approximately three square inches of the material under test, and then measures on a comparative basis the total illumination reflected from this area of the material. The standard for comparison may be another similar sample, the surface of a block of magnesium carbonate, or any other desirable standard.

The sample whose total reflection factor is to be measured is illuminated by a parallel beam of light normal to the surface under test, and is "viewed" by two photocells placed at an angle of 30 degrees from this surface. The combined output from these photocells is applied to a galvanometer, and balanced by the steady output of a third photocell, applied to the galvanometer through a slide wire bridge contained within the instrument.—*Electronics, December, 1932.*

U. S. PATENTS IN THE FIELD OF ELECTRONICS

Radio Circuits

Automatic volume control. Method of controlling the amplification of one or more tubes of the shielded-anode type by rectifying the amplified signal and using this energy for varying the voltage applied to the shielding electrodes. O. H. Schade, assigned to Atwater Kent. Filed March 22, 1928. No. 1,887,329. See also No. 1,885,307, Sarkes Tarzian, to Atwater Kent, in which variations in plate and screen voltage are made simultaneously to effect a substantial change in the amplification.

Grid suppressor. Circuit in which a resistance is placed in series with the grid of the tube to prevent instability at the higher radio frequencies. A. D. Silva, assigned to A. K. Co. Original filed July 26, 1924. No. 1,885,301.

Radio-wired radio system. Method of using either wired radio or space radio receivers at the will of the operator. C. R. Rowe, assigned to Wired Radio, Inc. Filed July 24, 1931. No. 1,886,230.

Feed-back prevention. A Wheatstone bridge amplifying system arranged so that no current of output frequency is fed back to the input circuit. Ernest Green, assigned to R.C.A. Filed in England. March 7, 1928. No. 1,878,309.

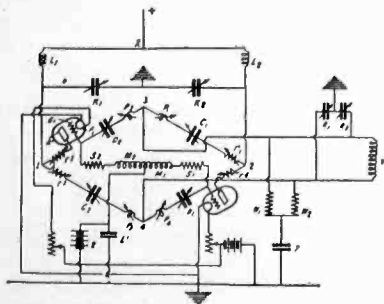

Diversity reception. A method of receiving wireless signals with geographically separated antennæ and method of impressing them upon a receiving system. A. H. Taylor and L. C. Young, assigned to Wired Radio, Inc. Filed July 28, 1928. No. 1,882,166.

Signaling by phase displacement. The energy supply to the antennæ is momentarily interrupted, meanwhile slightly detuning the antennæ a predetermined amount for the time necessary to produce phase reversal. E. F. W. Alexander, assigned to R.C.A. Filed Dec. 9, 1927. No. 1,882,698.

Volume control system. Two patents granted to E. R. Hentschel and assigned to Wired Radio, Inc., No. 1,884,680 and No. 1,884,681 for automatically controlled volume. One includes a degeneration system for feeding back energy to the antennæ of an opposite phase to control volume.

Receiving system. Total resistance of the output circuit is substantially zero both for the high frequency and

the modulation frequency. B. Van Der Pol, assigned to Philips. Filed in Holland, Feb. 29, 1924. No. 1,886,990.

Stabilizing system. Between the grid of one tube and the grid of the following tube is a series circuit consisting of two variable condensers and two variable resistors. The mid point of the circuit is connected to ground. Samuel Cohen, assigned to General Instrument Corp. Filed Feb. 17, 1925. No. 1,883,580.

Selective circuits. A pre-selector system designed to get rid of an undesired frequency and to pass through to the first tube the desired band. J. K. Johnson, assigned to Hazeltine Corp. Filed July 7, 1931. No. 1,883,794.

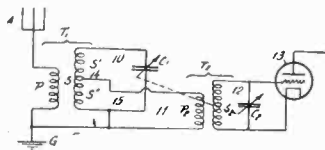

Frequency modifier. An overneutralized amplifier using the Rice circuit. Oscillations appear in the anode circuit for periods of time greater than the time of a cycle at the harmonic frequency to which the plate circuit is tuned. The grid is tuned and excited at the fundamental frequency. C. W. Hansell, assigned to R. C. A. Filed March 23, 1927. 38 claims. No. 1,878,308.

Electron Tube Circuits

Regenerative photoelectric cell circuit. A method by which an initial light impulse is amplified and additional light variations are produced in the photo-cell circuit to produce a final amplified electrical variation. B. Kwartin, Philadelphia, Pa. Filed December 2, 1927. No. 1,880,020.

Resistance-cell circuit. Method of connecting two photocells in push-pull through two triodes whose outputs are connected in parallel and then to the input of a third triode. C. F. Jenkins, assigned to Jenkins Laboratories. Filed January 3, 1928. No. 1,879,687.

Light control arrangement. Apparatus for controlling light beams passing through a Kerr cell comprising a vacuum tube oscillator having a portion of its oscillatory circuit shared by the Kerr cell and a modulator tube. Alexander Meissner, assigned to Telefunken. Filed July 2, 1926. No. 1,880,102.

Train control. Method of using amplifier tube, etc., for signaling and train control. E. H. Loftin, assigned to General Railway Signal Co. Filed October 4, 1924. No. 1,877,920.

Oscillation generator. Method of generating oscillations by interrupting a light beam shining on photo-sensitive surfaces. Harry Reifel, assigned to

Wired Radio, Inc. Filed October 31, 1930. No. 1,880,105.

Detector. Between the cathode and the grid return of the triode is a device with a non-linear characteristic. P. G. Weiller, Bloomfield, N. J. Filed April 3, 1930. No. 1,878,046.

Oscillation generator. Method of interrupting a beam of light rays impinging upon a photo-sensitive surface at a definite predetermined frequency. Harry Reifel, assigned to Wired Radio, Inc. Filed Oct. 31, 1930. No. 1,880,105.

Interstage transformer. Method of securing uniform transmission of a wide band of frequencies by having input and output transformer windings on a transformer, a certain portion of which is common, having a magnetic reluctance high compared to that of the other portions of the core inductor. V. T. Grimley, assigned to B. T. L. Filed Aug. 31, 1926. No. 1,881,515.

Gaseous tube circuit. A gas-filled discharge device in which the gas ionization produces an effective negative resistance between cathode and control electrodes for impressed waves of alternating current. C. R. Keith, assigned to B. T. L. Filed March 24, 1928. No. 1,881,657.

Modulation system. A crystal-controlled tube which has its output fed into a push-pull amplifier which couples to the antenna. The output of the modulation tube is connected in series with the plate supply of the push-pull tube. C. A. Culver, assigned to Wired Radio, Inc. Filed Aug. 3, 1928. No. 1,882,122.

Neutralized amplifier. A Rice-neutralized amplifier in which the center of the inductance is secured by means of a mid-tapped resistor. A. G. Jensen, assigned to W. E. Co., Inc. Original application filed Dec. 4, 1924. No. 1,884,711.

Combined oscillator and modulator. A piezo-controlled tube with two grids modulated by having the low frequency put upon one of its two grids. J. A. Willoughby, Cambridge, Mass. Filed Dec. 18, 1928. No. 1,884,945.

Magneto strictive vibrators. Series of patents granted to C. W. Pierce on various vibrators and applications of the magneto strictive type. Nos. 1,882,393 to 1,882,401 inclusive.

Electron Tubes

Light sensitive device. Gaseous tube consisting of a light sensitive surface, gas being at a pressure of about 75 to 90 microns. E. D. Wilson, assigned to Westinghouse E. & M. Co. Filed April 23, 1930. No. 1,884,464.

Thermionic cathode. Electron emitting material substantially of homogenous character, capable of being forged into wire consisting of a base metal selected from a group consisting of nickel and cobalt, said base metal containing about 0.5 per cent titanium and about 10 per cent metal selected from a group consisting of titanium and iron with about 2 to 10 per cent alkali-earth, metal, oxide, uniformly distributed through width. D. C. Halliwell, assigned to Westinghouse E. & M. Co. Filed Dec. 14, 1928. No. 1,883,898.

Photo-cell amplifier combination. A container having a partition dividing it into two portions with the photo-sensitive element in one portion and the amplifying tube in the other. Harley Iams and V. K. Zworykin, assigned to W. E. & M. Co. No. 1,883,926. Filed May 1, 1930.

Reactivation of filament. Arrangement for reactivating electron emission tubes comprising a source of cathode heating current, a source of direct anode potential, including a resistance having a high positive temperature coefficient to limit the space current and means momentarily to open up the anode potential. L. L. Jones, J. A. Flanzler and Emil Reisman, assigned to Technidyne Corp. Filed Oct. 29, 1929. No. 1,881,645.

Electronic Applications

Circuit controller. A system for locking a part of a motor-driven machine when machine is in motion by means of a vacuum tube. B. Stansbury and P. Crout, assigned to Cutler-Hammer, Inc. No. 1,880,367. Filed Nov. 19, 1930.

Time delay apparatus. A condenser-resistor system used as an energy storage. H. P. Thomas, assigned to G. E. Co. Filed Oct. 3, 1930. No. 1,880,576.

Color determination. Recording color by separating light into its constituent wavelengths, separating one wavelength into separate beams, projecting beams upon a test surface, projecting another beam upon a known tested surface, recording the color effect by the action of the electric current produced. G. Q. Voigt, Medford, Mass. Filed Jan. 22, 1930. No. 1,881,336.

Electronic control of oil burner. Method of controlling the operation of a burner by means of a grid-glow tube. F. S. Denison, assigned to Minneapolis-Honeywell Regulator Co. Filed Dec. 4, 1930. No. 1,880,871.

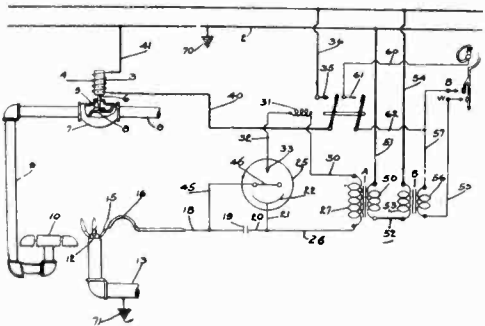

Photo-cell amplifier. Method of accentuating high audio frequencies in coupling the light sensitive cell to an amplifier. W. F. Tedham, London, assigned to Victor Talking Machine Co. Filed June 24, 1930. No. 1,884,376.

Cable testing equipment. Method of using thermionic tube of the grid control gaseous type. H. S. Hubbard, assigned to G. E. Co. Filed March 24, 1932. No. 1,886,682.

Electric control system apparatus. A series of patents granted to F. M. Slough, assigned to the Anderson Co., for remotely indicating the value of variable pressure, etc., one of them, No. 1,885,048, filed Oct. 7, 1924, having 131 claims. Other patents to the same com-

pany and along similar subjects are No. 1,885,054, J. W. Anderson; 1,885,052, 1,885,050 and 1,885,051 to T. J. Smulski.

Vacuum tube tester. Method of testing a vacuum tube by impressing alternating current to the plate and filament and by shorting a resistance varying the grid bias so as to get a differential in plate current. W. N. Goodwin, Jr., assigned to Weston. Original filed Aug. 17, 1927. Reissue No. 18,641.

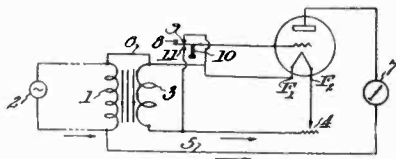

Light control. Method of connecting a Kerr cell having more than one variable electrode in series with the plate circuit of a tube. August Karolus, assigned to R.C.A. Filed in Germany. June 20, 1924. No. 1,885,604.

Method of taking soundings. Method of transmitting and receiving elastic waves in water and transforming them into electrical oscillation. Marcel L. Touly, Paris, France. Filed in France, Oct. 28, 1926. No. 1,885,652.

Humidifying Apparatus. Method of using photocell and an amplifier for regulating the amount of water vapor in a fluid. S. M. Anderson, assigned to B. F. Sturtevant Co. Filed Feb. 6, 1931. No. 1,885,791.

Light control circuit. A feed-back circuit in which variations in the intensity of light impinging upon a photo-sensitive cell varies the grid bias of the tube. E. O. Hulburt and W. H. Crew, Washington, D. C. Filed Dec. 23, 1927. No. 1,886,813.

Telegraph circuit. The use of a grid controlled gaseous rectifier in a telegraph receiving or repeating circuit. A. E. Frost, assigned to W.U.T. Co. Filed April 10, 1930. No. 1,881,458. See No. 1,882,817 to Hakon H. Haglund, also to Western Union.

Synchronism indicator. Method of using vacuum tube transmitters of high frequency current for indicating synchronism. E. F. Carter, assigned to G. E. Co. Filed July 22, 1927. No. 1,885,078.

Measuring surface flatness. Method consists in actuating a hair line member according to the irregularities of a surface and projecting the image of the hair line onto a moving photographic film. E. C. Erickson, assigned to B.T.L., Inc. No. 1,880,942. Filed July 7, 1930.

Traffic signal system. Method by which sound on a side street changes lights at an intersection by means of thermionic tubes, to permit a car approaching on a side street from getting the safe signal. C. F. Whitney, assigned to G. E. Co. Filed Nov. 19, 1928. No. 1,880,618.

Sound recording system. Method of using a corona discharge to expose moving film. J. R. Balsley, assigned to Fox Film Corp. No. 1,881,040. Filed Nov. 18, 1929.

Broadcasting system. A double modulation system of broadcasting. John Hays Hammond, Jr., Gloucester, Mass. No. 1,851,175. Also No. 1,851,174.

Broadcast distribution system. Apparatus for multiplex relaying of radio signals. E. E. Clement, assigned to E. F. Colladay, Washington, D. C. No. 1,851,495.

Power conversion apparatus. A combination of a source of d.c. and an alternating current load circuit subject to substantial load variations, energy converting means having a highly negative volt ampere characteristic. A. F. Fitzgerald, assigned to G. E. Co. Re-issue No. 18,398.

Frequency production and control. Two patents granted to W. A. Marrison, assigned to B. T. L., Inc., on the use of a cathode ray tube for the production and control of frequencies. The electron beam is caused in one case to describe a circular path and impinge upon a segmented electrode with alternate insulated and conducting surfaces. This electrode is connected to an external circuit in which will flow a frequency dependent upon the number of segments in the electrode and the rate at which the electron beam describes the circle. No. 1,882,849 and 1,882,850. Filed July 31, 1929 and Aug. 5, 1925, respectively.

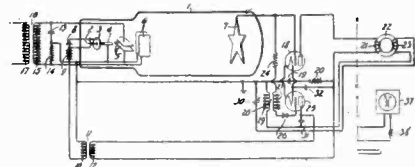

Television, Facsimile, Etc.

Television system. A scene is analyzed and the impulses are recorded upon an electromagnetic tape. J. H. Hammond, Jr., Gloucester, Mass., No. 1,867,542.

Photo-electric relay. A birefringent liquid and means for subjecting it to the action of two electric fields at an angle with respect to each other, so that the liquid is rendered doubly refractive to light rays and the quality is constantly maintained. Fritz Michelsen, assigned to G.O.T., No. 1,870,017.

Electron Tubes

Electric discharge tube. An electric rectifier comprising a discharge vessel having an anode, a cathode of molybdenum and an addition of from 0.25 per cent to 10 per cent thorium in metallic state and a filling of inert gas at a pressure from about three mm. up to about 30 mm. mercury column. Rudolf Loewit, Berlin, Germany. No. 1,876,991.

Tube filament. A filament composed of a metal coated with a layer of glass and in turn being coated with a layer of gallium, Pierre Creuzé, Paris, assigned to Pierre Creuzer, France. No. 1,866,195

BRITISH PATENTS IN THE FIELD OF ELECTRONICS

Radio Circuits

Interference eliminator. Method of eliminating weak interference, particularly the beat caused by one of two common-wave transmitters consisting of a piezo-electric crystal shunted across the input to the second detector of a superheterodyne receiver. Owing to its sharp resonance the crystal has no appreciable effect on cutting down the side bands of the desired program but eliminates by its very sharp response the undesired single note of any frequency within 200 to 5,000 cycles of carrier frequencies. W. S. Barden, Marconi Co. No. 376,175.

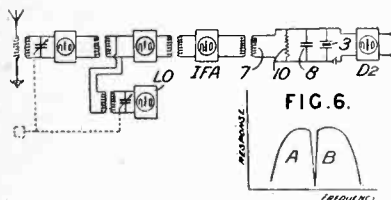

Frequency circuit. A crystal-controlled two-grid oscillator has the crystal across the two grids. The output from the tube is taken from the plate in a normal fashion. The frequency is maintained steady under varied conditions of load and supply. J. B. Dow, assigned to Wired Radio, Inc. No. 376,511. Also No. 377,067.

Automatic volume control. In a high-frequency receiver comprising several amplifier members in cascade means are provided to vary the gain operated by the detector output, first of one of the cascade amplifier members, then successively the gain of the other amplifier members if the output exceeds a predetermined value. G. A. Mathieu, assigned to Marconi Co. No. 377,307.

Short wave oscillator. In an ultra short wave system undesired oscillations are eliminated by making the effective electrical links of the cathode leads equal to an odd number of half wavelengths. B. Salzberg, assigned to Marconi Co. No. 377,535.

Linear amplifier. Distortion due to non-linearity in the relation between input and output of a tube amplifier is removed by combining the main output with the output of an auxiliary amplifier, the input to which is suitably controlled. Siemens & Halske. No. 377,563.

Aviation aid. A system for facilitating the landing of aircraft comprising four directional transmitters radiating concentrated beams of constant strength from outside the landing space in four mutually perpendicular directions over the landing space on the same wavelength and with different modulation frequencies. Telefunken. No. 377,624.

Interstage coupling. An input or interstage coupling comprising a transformer with a tuned secondary and a

primary magnetically coupled and in addition capacitively coupled in an opposing manner. Primary winding is resonant at a frequency slightly above the highest frequency of the tuning range so that the efficient amplification of the lower frequency and stable amplification of the higher frequency in the range is obtained. W. A. MacDonald, Hazeltine Corp. No. 378,134.

Automatic tuning system. To obtain uniform amplification throughout a desired frequency range, the input impedance of the thermionic amplifier is caused to vary inherently and automatically with frequency in such a manner that the input circuit becomes resonant to whatever frequency is supplied thereto over a wide range of frequencies. W. van B. Roberts, Marconi Co. No. 378,256.

Stabilizing circuit. The use of transmission lines for obtaining selectivity in receivers and stability in oscillators. C. W. Hansell and J. L. Finch, Marconi Co. No. 378,350.

Silent tuning circuit. In connection with an a.v.c. receiver, a means automatically for rendering the signal reproducer inoperative when the intensity falls below a predetermined level, thereby eliminating background noises during tuning. The method involves the use of an electromagnetic relay with proper provision to prevent sparking at contact. A. F. Van Dyck, Marconi Co., No. 372,155.

Superheterodyne receiver. The frequency of a local oscillator in a superheterodyne receiver is controlled from a remote point. The oscillator is of the multi-vibrator type and its frequency is adjusted by varying the effective value of a resistance. For this purpose a valve is connected across the resistance and varied in impedance by controlling its grid bias by a variable resistance at the remote point. W. R. Koch, Marconi Co., No. 372,687.

High-frequency oscillator. A tube with a high positive grid and negative anode. To maintain oscillation a "catalyst" element comprising a metal strip one-half wave length long is coupled to the anode. B. Salzberg, Marconi Co., No. 372,660.

Stabilizing circuit. To stabilize the frequency of a thermionic oscillator the back coupling is taken from parts of the output circuit in which high-frequency currents have a phase difference dependent upon the frequency, and harmonics of these currents are made to beat with each other to produce the fundamental frequency which is fed back to the grid circuit. Telefunken No. 373,632.

Direct-coupled amplifiers. By a source of suitable values of coupling resistances in direct-coupled amplifiers, a sudden discontinuous change in the plate current is caused by applying d.c. voltage of one kind to the input grid while a sub-

sequent input voltage of the opposite kind restores the plate currents to their original value. D. T. Evans. No. 373,309.

Superheterodyne receivers. To facilitate the ganging of the tuning of a superheterodyne receiver, the oscillator is tuned to the signal and the required different frequency is produced by an auxiliary oscillator tuned to the intermediate frequency and only one of the side frequencies produced by modulation is used to beat with the signal frequency. W. V. B. Roberts, Marconi Co. No. 372,692.

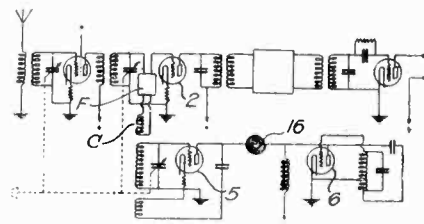

Superheterodyne. The local oscillator is so constructed and connected to the tuning element for the incoming signals that it will only oscillate if the oscillation frequency is less, or greater, than the frequency to which the signal receiving circuits are tuned. Reception of the "image" frequency is thus avoided. G. E. Company. No. 370,101.

Thermionic relays. The patent relates to a.c. relays suitable for controlling temperature or the flow of liquid and of the kind in which variations in the plate current of the tube are brought about by open or closing contacts in the grid circuit. J. L. Finch, Marconi Co., No. 372,654.

Television Apparatus

Cathode ray system. A method by which light is projected through a cathode ray tube onto a viewing screen external to the tube itself. V. K. Zworykin, Marconi Co. No. 376,498.

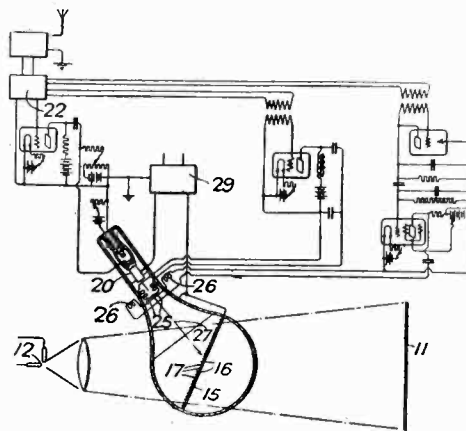

Television system. A system in which each point of a picture is given a characteristic frequency, currents varying in amplitude in accordance with the brightness of the picture, points being transmitted simultaneously for all the points of the picture. Telefunken. No. 377,169.

Television receiver. Means of getting a second image from a scanning disk for purpose of monitoring. H. E. Ives, assigned to Electrical Research Products, Inc. No. 374,974.

Index to **electronics**—Volume IV + V

January to December issues, inclusive, 1932

McGraw-Hill Publishing Company

330 West 42nd Street, New York City

Pages by Issues

January	1-38
February	39-76
March	77-114
April	115-150
May	151-182
June	183-214
July	215-246
August	247-274
September	275-304
October	305-328
November	329-356
December	357-386

(ed) Editorial * Illustrated (N) News

Acoustics:

Electronics' chart of sound levels	43
Modern treatment of broadcasting acoustics. S. K. Wolf	*14
WCAU'S acoustic features	*358

Aeronautics:

Improvements in frequency multipliers for aircraft radio. E. G. Watts	124
---	-----

Amplifiers:

Class B amplifier distortion. C. L. Farrar	*196
Extensively used patents relating to amplifying circuits	221
Heavy duty industrial amplifier tube. C. B. Upp	*162
High-gain amplifiers for electronic measurements	319
Improved 120-volt d.c. audio amplifier. C. F. Stromeyer	*194
Licenses under the amplifier patents	152
Measurement of Class B amplifier distortion. C. L. Farrar	*196
One tube balanced circuit for d.c. amplifier	*318
Output amplifiers for 110-volt d.c. receivers. J. R. Nelson	*128
Push-push amplification. C. E. Kilgour	*82
Resistance-coupled amplifier for television. C. B. Brown	*265
Visual tuning of band-pass amplifiers. Rinaldo De Cola	*58

Book reviews 165, 206, 298, 341

Broadcasting:

Acoustic features of WCAU's new studios	*358
"Clear channels" being destroyed under pressure of expediency	216
Directional antennae for broadcasting. R. M. Wilmette	*362
Effects on reception of over modulation. C. E. Kilgour	*9
Modern treatment of broadcasting acoustics. S. K. Wolf	*14
Piezo-electric loudspeakers and microphones. A. L. Williams	*166
Senate inquires into government broadcasting	103
Shall we widen the broadcasting band?	276
Weather's influence on sound absorption	315

Cathode Rays:

New cathode-ray oscillograph tube. G. F. Metcalf	*158
Thyratron linear time axis for cathode-ray oscillograph. H. Neustadt	*198

Electron Tubes:

Discovers "neutron" bound positive and negative particles	103
Electronic charges build up million volts	95
To build 15,000,000 volt tube at M.I.T.	102

General Electronics Corp. (ed) 347

High Frequency:

Bibliography	169
Cathode-ray frequency multiplier	264
Hawaii has ultra short wave service	27
New forms of short wave tubes. I. E. Mouremtseff, G. R. Kilgore and H. V. Noble	*278
Study of high frequency heating. K. C. DeWalt	*338
Ultra-short wave receivers. R. Raven-Hart	*23

Lights and Lighting:

Artificial light needed 30 per cent of time in school room	229
Control of window lighting by tube circuits	*229
Neon-filled lamps for series operation	261
Sodium-vapor lighting in Holland	*253
Zinc vapor lamp (N)	*174

Measurements:

Aspects of standard signal generator design. J. D. Crawford	*46
Beat, frequency oscillator control determining proper plate shape. G. F. Lampkin	*369
Broadcast transmitter measurement. E. A. Laport	88
Curve plotter and comparator. Samuel Isler	*361
Determining field distribution by electronic methods. E. D. McArthur	*192
Dielectric constant measurement	264
Dynamic tube measurements. W. N. Tuttle	344
Electronic devices in a testing laboratory. C. H. Sharp	*284
Electronic oscillograph lightning studies	233
Electronic speed and acceleration recorder. H. M. Partridge	*262
Electronic timer for very short intervals. H. W. Lord	*309
Gas pressure measured. H. C. Rent-schler	292
Grid-glow micrometer. R. W. Carson	*191
High resistance measurement. F. A. Lidbury	*94
Instantaneous pressure in shotguns	314
Measuring acidity and alkalinity by photocell	232
Piezo electric methods of measuring mechanical forces. I. J. Saxl	*292
Sensitizing the wavemeter for intermediate frequencies. A. G. Richardson	*130
Standard microvolter using 2nd harmonic principle. W. F. Diehl	*230

Music:

Electronic orchestra at Berlin	319
Laboratory study of the sound of musical instruments	58
New music of electronic oscillations	*86
Pitch control for an electronic musical instrument. T. R. Bunting	*287
Pitch of instruments	260
Recording long programs or books. I. J. Saxl	*85

Neon Tubes:

Lamps for series operation	261
Transformers for gaseous discharge tubes. R. F. Trimble	*282
New products	31, 69, 107, 143, 178, 207, 239, 271, 299, 325, 351, 379

Noise:

Electronics chart of sound levels	43
Measuring vs. "judging" loudness of noise	21
Noise proof house. E. E. Free	134
Recorder for comparing street car sounds. George Phillips	*99
Testing tires for noise	229

Patents:

British patents	
73, 111, 147, 215, 244, 355, 383	
British procedure (N)	175
Extensively used patents relating to amplifying circuits	221
Licenses under the amplifier patents	152
Problems in the field of electronics. H. A. Toulmin, Jr.	*306
Proposed patent office reforms	116
U. S. patents	34, 72, 109, 145, 180, 210, 241, 273, 301, 327, 353, 381

Photo-Electric Cell:

Characteristics of the photonic cell	168
Galvanometer, distant reading, employs photo-cells	21
Manufacture of caesium silver-oxide photo-cell. W. H. Nickless	*255
Photo-cells from rectifier disks. E. D. Wilson	*312
Radio tubes as photo cells. W. P. Koehler	*372

Photo-Electric Cell—Industrial Applications:

Adjusting illumination in tunnels and movie houses	200
Aeronautic field lights turned on by cell	291
Automatic control of airport lighting on runways. R. A. Holmes	135
Automatic weighing of batches	*98
Camera guards laboratory	134
Counterfeits detected by electric eye	135
Doors opened with wave of hand	*49
Egg-candling machine uses photo-cell	*228
Elevator doors controlled by photo-cell. C. E. Ellis	*54
Engineering contractors use photo-cells	200
Freight car movements	314
Heat tempering of valves controlled by photo-cells	232
Infra-red rays work new sextant	201
Inspection device with "memory"	201
Integrator for irregular areas	98
Matching colors of samples at three points. E. D. Wilson and others	*342
Photo-electric control in the printing arts	*334
Photo-cell control of temperature for filament coating ovens. W. P. Koehler	*170
Photo-cell operates spray priming lumber	200
Precision inspection work. Tietz & Paulson	*6
Razor blades tested	290
Robot humidifier actuated by moisture on window pane. B. S. Hayens	*61
Safeguards on Radio City elevators	343
Scales weigh automatically	*135
Sensitive cell counts light quanta	168
Smoke rings bell, lights sign, records time	291
"Telepoise" with light sensitive bridge for weighing. E. J. White	*60
Testing raw silks	*343
Photo-cell operates huge sign. G. S. Mitchell	99
Uses for photo-electric counters	315
Watches for earthquakes, gives alarm	135

Radio:

Auto radio	48
Automobile tube of increased output. M. Bareiss	*96
Canada's radio production	26
Causes of radio complaints (chart)	235
Chart surveying by electronic methods	60
Cost of engineering radio sets	95
Development of B-battery devices for auto-radio	*80
Distance range of radio waves (chart)	163
Ether spectrum chart showing recent radio reallocation	120
Improved B eliminator for automobile receivers. W. W. Garstang	*254
Improvements in frequency multipliers for aircraft radio. E. G. Watts	124

SHAKEPROOF



"It's the Twisted Teeth that LOCK"

Explain *THIS* to *YOUR* P. A.

• • • "Sure! There are other lock washers that cost less than Shakeproof, but that's no reason we should use them. I specified Shakeproof because it's the only lock washer with twisted teeth—the only lock washer that will really hold nuts and connections tight. It's going to cost us a lot more to use an inferior washer because we are bound to have more service trouble and a lot of dissatisfied customers. Let's not fool ourselves by buying on price alone—let's decide this thing on performance and give our product the extra protection that Shakeproof provides!"

P. S. Maybe a test in your own shop will be more convincing—mail the coupon for samples today!

Shakeproof representatives are located in the following cities:

- New York City
- Philadelphia
- Boston
- Pittsburgh
- Schenectady
- Detroit
- Cleveland
- Toledo
- Cincinnati
- Birmingham, Ala.
- Dallas, Texas
- Milwaukee
- Los Angeles
- San Francisco
- Seattle
- Toronto, Ontario, Can.

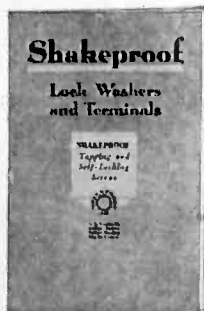

SHAKEPROOF Lock Washer Company

(Division of Illinois Tool Works)

2539 N. Keeler Avenue

Chicago, Illinois

Coupon Gentlemen: Kindly send us your complete catalog and price list. Also, please send us testing samples as indicated.

Type..... Size.....

Type..... Size.....

Firm Name.....

Address.....

City..... State.....

By..... Title.....

Type 12. Internal. For S. A. E. and Standard Machine Screws

Type 11. External. For Standard Bolts and Nuts

Type 15. Countersunk. For all Countersunk Screws

Type 20. Locking Terminals. For Radio and Electrical Work

U. S. Patents
1,419,564—1,604,122
1,697,954—1,782,387
Other Patents Pending. Foreign Patents.

[Continued from page 384]

Method for finding distance of vessel from source of radio	260	New tubes—detectors, rectifiers, amplifiers	118, 252	Knipp, C. T., and H. A. Brown. Power detection characteristics of pentode tubes	120
1932 census of manufacture	26	Radiation-cooled power tubes for radio transmitters. H. E. Mendenhall	316	Knowles, Hugh S. Improved fidelity of two speaker radio receivers	154
"Open patent pool" in sight	28	Selling tubes on consignment	184	Koechel, W. P. Circuit for determining heating time of vacuum tubes	293
Padding condenser of superheterodynes. B. F. McNamee	160	Shrinkage control in radio tube manufacture. L. L. Schreiner	332	Photocell control of temperature for filament coating ovens	170
Police radio reception. G. F. Lampkin	22	Status of cold cathode tubes abroad. I. J. Saxl	17	L AMPKIN, G. F. Economics of police radio reception	22
Polysdorff cores for superheterodynes	131	Testing of mercury vapor power tubes. J. L. Zehner	224	Beat, frequency oscillator control determining proper plate shape	369
Power detection characteristics of pentode tubes. Brown & Knipp	126	The 59-type power output tube. K. W. Jarvis	310	Landon, V. D., and E. A. Sven. Solution of the superheterodyne tracking problem	250
Radio during solar eclipses. A. E. Kennelly	248	The r.f. pentode. E. W. Ritter	10	Laport, E. A. Broadcast transmitter measurement	88
Radio Manufacturers' Assn.—Trade show	186	Vacuum tube performance vs. manufacturing tolerances. W. Charton	44	Laszlo, S. E. Can radio tubes be sold abroad?	92
Range-finder traces birth and path of storms	20	Variation of grid plate capacity of 58 type tube	319	Lewin, George. Frequency characteristics in film recording and reproducing	40
Receivers show improved technical design	218, 330	Vacuum Tube Applications:		Loechel, W. P. Radio tubes used as photo cells	372
Reception and sunspots. H. T. Stetson	122	Controlling street lights and water heaters by "carrier currents." Guy Bartlett	98	Lord, H. W. Electronic timer for very short intervals	309
Reducing man-made static. G. H. Browning	366	Electronic high speed timing device. W. M. Roberds	90	M ARTHUR, E. D. Determining field distribution by electronic methods	192
Ribbon microphone. Julius Weinberger	336	Electronic soundings give ship's location despite fog	134	McNamee, B. F. Padding condenser	160
Solution of the superheterodyne tracking problem. Landon & Sven	250	Electronic welding	314	Mendenhall, H. E. Radiation-cooled power tubes for radio transmitters	316
Statistics for 1931	77	Glow tube checks over and under voltages	290	Metcalf, G. F. New cathode-ray oscillograph tube	158
Test 20 lb. portable 5 meter transmitter (N)	175	Heating in industry	291	Mourontseff, I. E., G. R. Kilgore and H. V. Noble. New forms of short wave tubes	278
Weak signal demodulation by a strong carrier. E. V. Appleton	171	Industrial uses of electronic diffraction. C. J. Phillips	84	N ELSON, J. R. Output amplifiers for 110-volt d.c. receivers	128
Radio Apparatus:		Lists tube uses	61	Neustadt, H. Thyatron linear time axis for cathode-ray oscillograph	198
Automatic voltage regulation. Kasson Howe	164	Making new emulsions at 300,000 cycles	95	Nickless, W. H. Manufacture of caesium silver oxide photocells	255
Ceramic, low thermal-expansion	94	"Radio knife" for marking leather, cutting glass	61	P ARTRIDGE, H. M. Electronic speed and acceleration recorder	262
I.F. transformers—cost vs. quality. Henry & Stemm	97	Rubber conveyors are synchronized by tubes	21	Paulson, C., and W. J. Tietz. Photoelectric cells in precision inspection work	6
Mercury vapor vacuum pump	95	Thermionic control for Chicago's fountain	315	Phillips, C. J. Industrial uses of electronic diffraction	84
Padding condenser. B. F. McNamee	160	Thermionic tubes in industry	5	R AVEN-HART, R. Ultra short wave receivers	23
Voltage quadrupler. W. W. Garstang	50	Thyatron voltage regulator. C. E. Weinland	132	Rentschler, H. C. Measurement of gas pressure	292
Wet versus dry electrolytic condensers	131	Tubes control Purdue's 3,500 lb. steam boilers	261	Richardson, Avery G. Direct reading short circuit test for vacuum tubes	233
Review of electronics literature here and abroad	28, 66, 104, 140, 176, 204, 236, 268, 296, 322, 348, 376	Tubes in a physiological laboratory	94	Sensitizing the wavemeter for intermediate frequencies	130
Sound Pictures:		Ultra sonic vibrations effect chemical changes	20	Ritter, E. W. The r.f. pentode	10
Advances in sound recording	4	WCAU's acoustic features	358	Roberds, W. M. Electronic high speed timing device	90
Economics of theater maintenance. W. W. Waltz	225	X-Ray:		S AXL, DR. IRVING J. Piezo electric methods of measuring mechanical forces	292
Frequency characteristics in film recording and reproducing. George Lewin	40	Million volt tube	292	Recording of long programs or books	85
Standardized 16 mm. sound on film	293	Fluoroscope	291	Status of cold cathode tubes abroad	17
Statistics for 1931	79	AUTHORS' INDEX		Schreiner, L. L. Shrinkage control in radio tube manufacture	332
Speakers:		A PPLETON, PROF. E. V. Weak signal demodulation by a strong carrier	171	Sharp, Clayton H. Electronic devices in a testing laboratory	284
Calculation of loudspeaker efficiency. Irving Wolf	52	B AREISS, M. Automobile tube of increased output	96	Stemm, R. E., and Charles C. Henry. I.F. transformers—cost vs. quality	97
Dynamic speaker design. A. R. Barfield	188, 257	Barfield, A. R. Dynamic speaker design. Pt. 1 •188, Pt. 2 •257		Stetson, H. T. Radio reception and sunspots	122
Improved fidelity of two speaker radio receivers. H. S. Knowles	154	Brown, C. Bradner. Resistance-coupled amplifier for television	265	Stromeyer, Charles F. Improved 120-volt d.c. audio amplifier	194
Piezo-electric loudspeakers and microphones. A. L. Williams	166	Series modulation for television transmitters	263	Sven, E. A., and V. D. Landon. Solution of the superheterodyne tracking problem	250
Resonator speaker	102	Brown, H. A., and C. T. Knipp. Power detection characteristics of pentode tubes	126	T IETZ, W. J., and C. PAULSON. Photoelectric cells in precision inspection work	6
Television:		Browning, Glenn H. Reducing man-made static	366	Toulmin, H. A. Jr. Patent problems in the field of electronics	306
Bibliography on television	265	Bunting, T. R. Pitch control for an electronic musical instrument	287	Trimble, Russel F. Transformers for gaseous discharge tubes	282
Resistance-coupled amplifier for television. C. B. Brown	265	C ARSON, ROBERT W. Grid-glow micrometer	191	Tuttle, W. N. Dynamic tube measurements over side ranges of values	344
Series modulation for television transmitters. Bradner Brown	263	Charton, W. Vacuum tube performance vs. manufacturing tolerances	44	U PP, C. B. Heavy duty industrial amplifier tube	162
Therapeutics:		Conway, Thomas E. Costs in radio tube manufacture	222	W ALTZ, W. W. Economics of theater maintenance	225
Latest in high intensity x-rays and "fever machines"	56	Crawford, John D. Aspects of standard-signal generator design	46	Watts, E. G. Improvements in frequency multipliers for aircraft radio	124
Thyatron:		D eCOLA, RINALDO. Visual tuning of band pass amplifiers	58	Weinberger, Julius. Ribbon microphone and its applications	336
High speed thyatron automatic counting	232	DeWalt, K. C. Study of high-frequency heating	338	Weinland, Clarence E. Thyatron voltage regulator	132
Thyatron linear time axis for cathode-ray oscillograph. H. Neustadt	198	Diehl, W. F. Standard microvolter using 2nd harmonic principle	230	White, E. J. Continuous weighing with light sensitive "telepoise"	60
Thyatron voltage regulator. C. E. Weinland	132	E DGERTON, H. E., and K. J. GERMESHAUSEN. Stroboscopic photography	220	Williams, Alfred L. Piezo-electric loudspeakers and microphones	166
Traffic Control:		Ellis, C. E. Photocell controlled elevator doors	54	Wilmotte, Raymond M. Directional antenna for broadcasting	362
Controlling street lights and water heaters by "carrier currents." Guy Bartlett	98	F ARRAR, CLYDE L. Measurement of Class B amplifier distortion	196	Wilson, E. D. Photocells from rectifier disks	312
Equestrian-operated traffic signals	260	G ARSTANG, W. W. Improved B eliminator for automobile receivers	254	Wilson, E. D., and others. Matching colors of samples at three points	342
Signaling to rubber-tired cars at 200 miles per hour	228	New voltage quadrupler	50	Wolf, S. K. Modern treatment of broadcasting acoustics	14
Vehicle tunnel in Paris uses photocells to control lights	200	Germeshausen, K. J., and H. E. Edgerton. Stroboscopic photography	220	Wolf, Irving. Calculation of loudspeaker efficiency	52
Ultra-Violet:		H ENRY, CHARLES C., and R. E. STEMM. I.F. transformers—cost vs. quality	97	Z EHNER, J. L. "Cheater circuits" for synthetic testing of mercury vapor power tubes	224
Detects oil adulteration	58	Howe, Kasson. Automatic voltage regulation	164		
Instruments measure loss of ultra-violet by smoke	95	I SLER, SAMUEL. Curve plotter and comparator	361		
Vacuum Tubes:		J ARVIS, K. W. 59-type power output tube	310		
Can radio tubes be sold abroad? S. E. Laszlo	92	K ENNELLY, DR. ARTHUR E. Radio during solar eclipses	248		
Circuit for determining heating time of tubes. W. P. Koechel	293	Kilgour, C. E. Effects on reception of over modulation	9		
Characteristics of American electronic tubes (chart). Keith Henney	308	Problems of push-push amplification	82		
Costs in radio tube manufacture. T. E. Conway	222				
Direct reading short circuit test for vacuum tube. A. G. Richardson	233				
Grid-controlled rectifier uses	318				
Heavy duty industrial amplifier tube. C. B. Upp	162				
Low noise vacuum tubes	169				
New forms of short wave tubes. I. E. Mourontseff, G. R. Kilgore and H. V. Noble	278				

MAGNAVOX

SPEAKERS and

CAPACITORS

MODEL 150

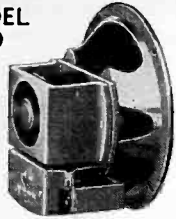

6" Dynamic Speaker

MODEL 152-X

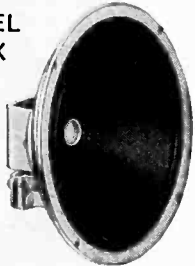

10" Dynamic Speaker

MODEL 254

Dynamic

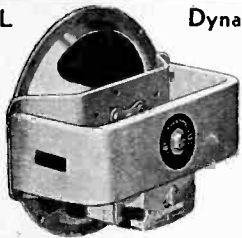

8" Permanent Magnet Speaker

MODEL 517

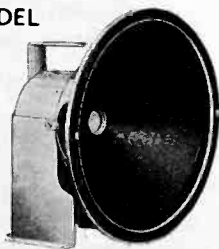

14" Dynamic For Public Address



Mershon Capacitors

Right Clamp Type



Left Stud Type Mounting

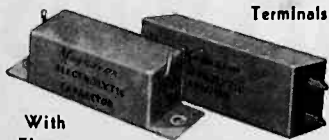

Lug Terminals

With Flange
MAGNAVOX Capacitors

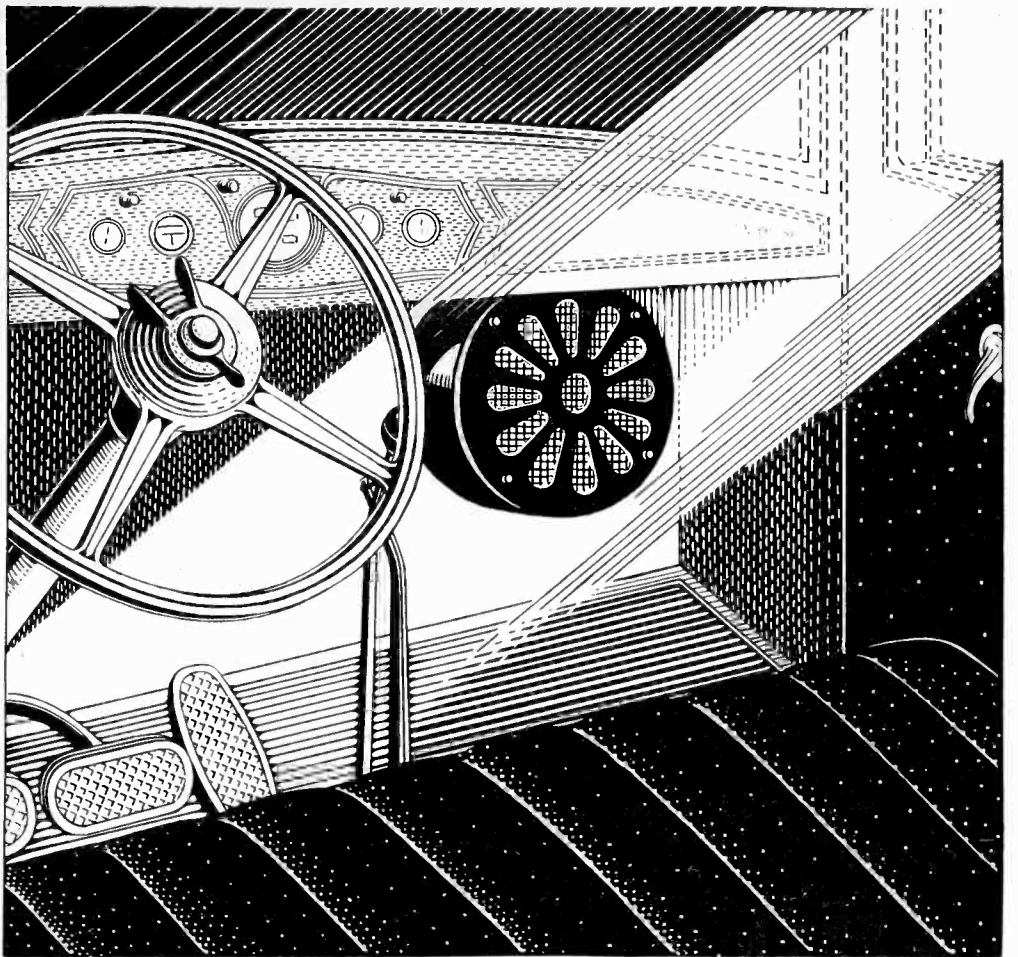

● MAGNAVOX AUTO SPEAKERS

● MAGNAVOX-QUALITY will help you secure trouble-free performance and long life under the difficult conditions which automobile radios must face. MAGNAVOX Engineering has mastered the tone problem --- the most difficult in auto radio --- and has added new features, assuring ease and simplicity of installation. That is why Magnavox Speakers are specified by a number of large manufacturers of radio sets for automobile use.

Rugged dust-proof design makes Magnavox Speakers a match for the punishment they are sure to receive in automobile use. The Single Stud Mounting makes installation on any dash easy.

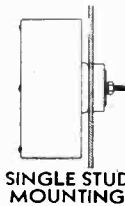

SINGLE STUD MOUNTING

Also remember Magnavox Permanent Magnet Speakers, --- ideal for automobile use, because there is no drain on the battery. Especially desirable for police cars that cruise long without battery attention.

Write for more information on any Magnavox product which interests you. Submit your specifications and ask for samples.

Magnavox Company Ltd.

ESTABLISHED 1911

GENERAL OFFICES AND FACTORY, FORT WAYNE, INDIANA

Subsidiaries

THE MAGNAVOX COMPANY, ELECTRO FORMATION, INC.,
MAGNAVOX (AUSTRALIA), LTD., MAGNAVOX (GREAT BRITAIN), LTD.

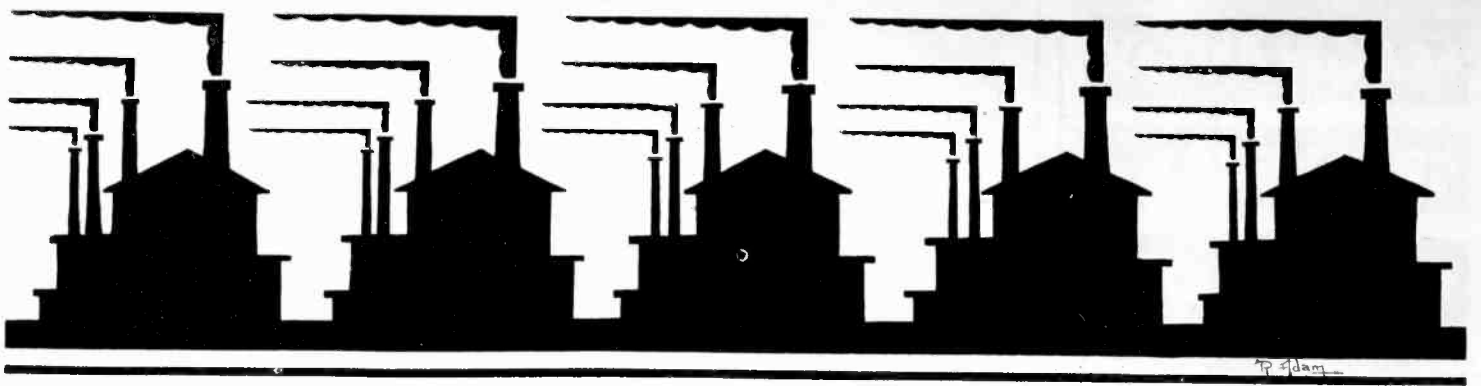

UNIFORMITY

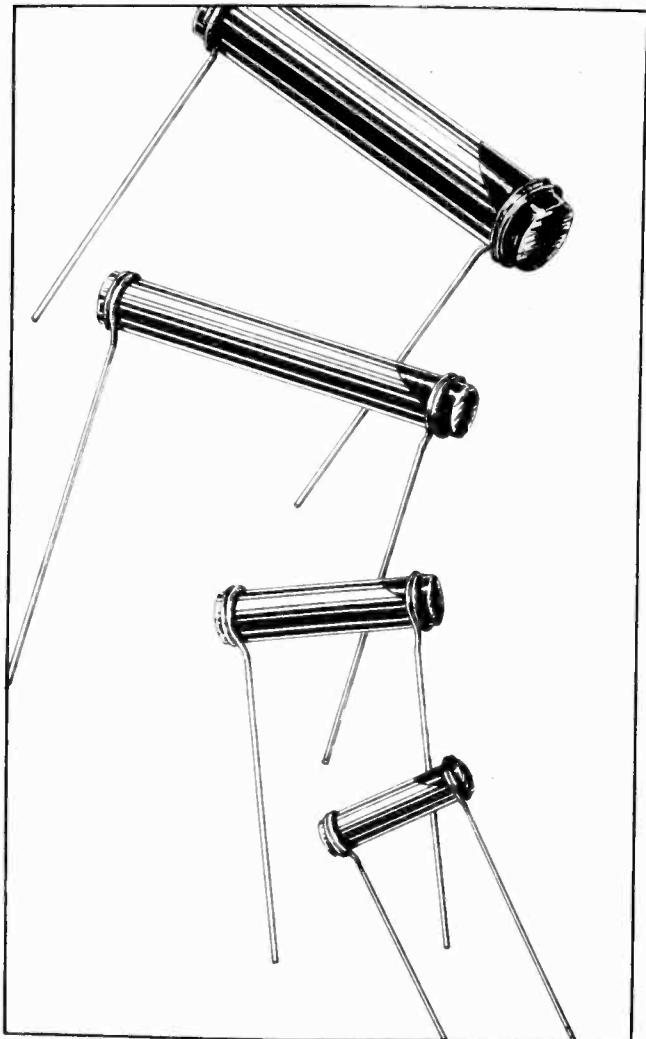

ERIE SUPPRESSORS

An ERIE SUPPRESSOR RESISTOR will not fail mechanically at 120° C. and 100% relative humidity.

The resistance unit is enclosed in a ceramic tube to protect it from mechanical breakage as well as from oil, dirt and moisture.

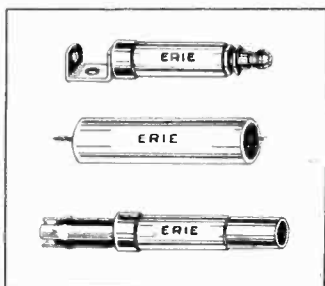

Continuous check and control on every manufacturing process is maintained by our engineering laboratories to insure absolute uniformity and highest quality in every Erie Resistor

Human errors have been eliminated by automatic machinery which detects variations without failure.

Because of the accurate control maintained over each step in the manufacturing processes and the elimination of human errors by automatic machinery it is now possible to make Erie Resistors within the desired limits instead of the old fashion method of manufacturing a large number—picking out the good ones and scrapping the balance.

Only by maintaining this uniformity and eliminating scrap is it possible to manufacture resistors having the highest quality and still hold the cost low enough to meet present day production demands.

ERIE RESISTORS



ERIE RESISTOR CORPORATION, ERIE, PA.
Factories in Erie, Pa., Toronto, Canada, and London, Eng.

December, 1932 — ELECTRONICS

It stands up in 50 Kw. broadcasting stations

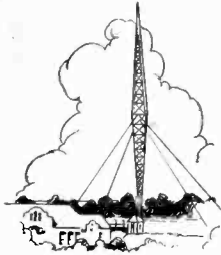

Long life, efficiency and uniform characteristics . . . proved in actual service

In step with the trend toward greater power output in radio broadcasting, Western Electric has consistently maintained its leadership as the manufacturer of new and improved apparatus.

The 232A tube—a water-cooled vacuum tube—was primarily designed for use in the final radio frequency stages of Western Electric, 50-kilowatt, radio broadcasting transmitters. The 132A socket used with this tube provides adequate cooling by means of a high-speed water stream in direct contact with the copper anode. Filament and grid lead-in wires pass through the same type of vacuum seals which are responsible for the success of external copper anodes. Internal electrostatic shielding of tube elements, subject to destructive discharges, allows the application of high plate potentials without injury to parts.

These features of design and the control of manufacturing processes assure operating uniformity of the 232A throughout a long life.

Whatever your electronic needs—make Western Electric equipment your standard for reliable, uniform operation.

Western Electric

ELECTRONIC EQUIPMENT

Distributed by GRAYBAR Electric Company

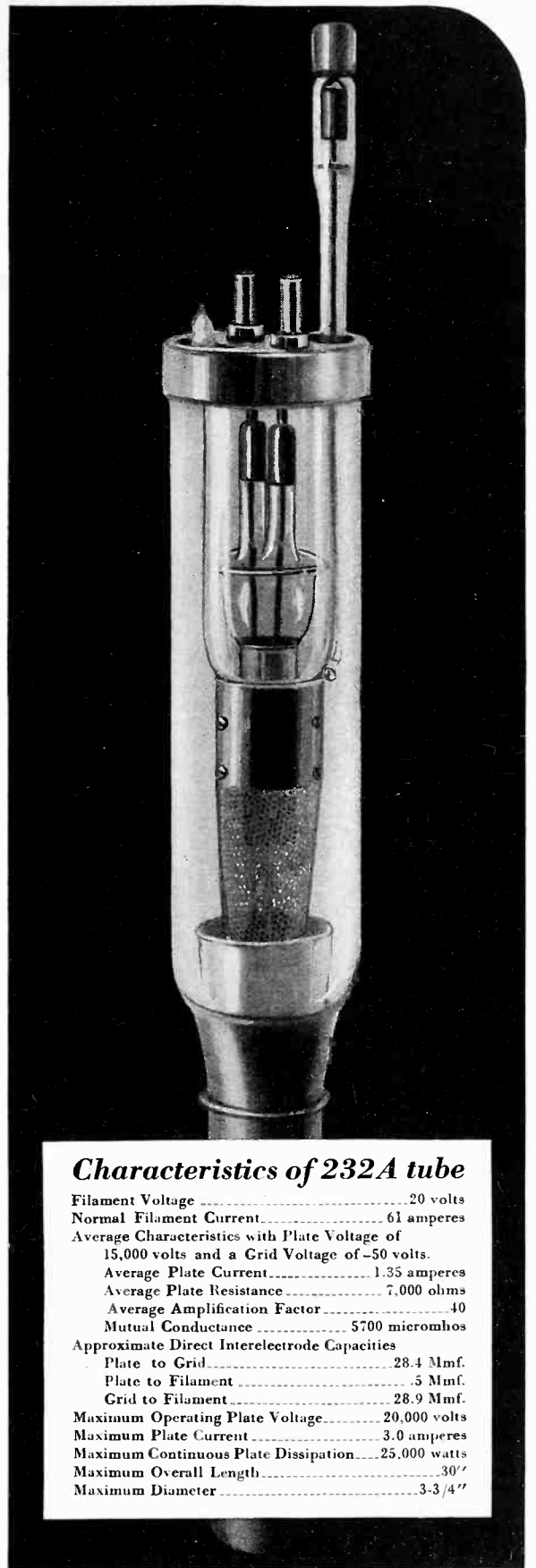

Characteristics of 232A tube

Filament Voltage	20 volts
Normal Filament Current	61 amperes
Average Characteristics with Plate Voltage of 15,000 volts and a Grid Voltage of -50 volts.	
Average Plate Current	1.35 amperes
Average Plate Resistance	7,000 ohms
Average Amplification Factor	40
Mutual Conductance	5700 micromhos
Approximate Direct Interelectrode Capacities	
Plate to Grid	28.4 Mmf.
Plate to Filament	.5 Mmf.
Grid to Filament	28.9 Mmf.
Maximum Operating Plate Voltage	20,000 volts
Maximum Plate Current	3.0 amperes
Maximum Continuous Plate Dissipation	25,000 watts
Maximum Overall Length	30"
Maximum Diameter	3-3/4"

GRAYBAR ELECTRIC CO. E12-32
 Graybar Building, New York, N. Y.
 Gentlemen: I would like information on the following electronic equipment: _____

 Tubes I am now using are: _____

 NAME _____
 ADDRESS _____
 CITY _____ STATE _____

Unusual beauty at moderate cost in this Bakelite Molded receiver case

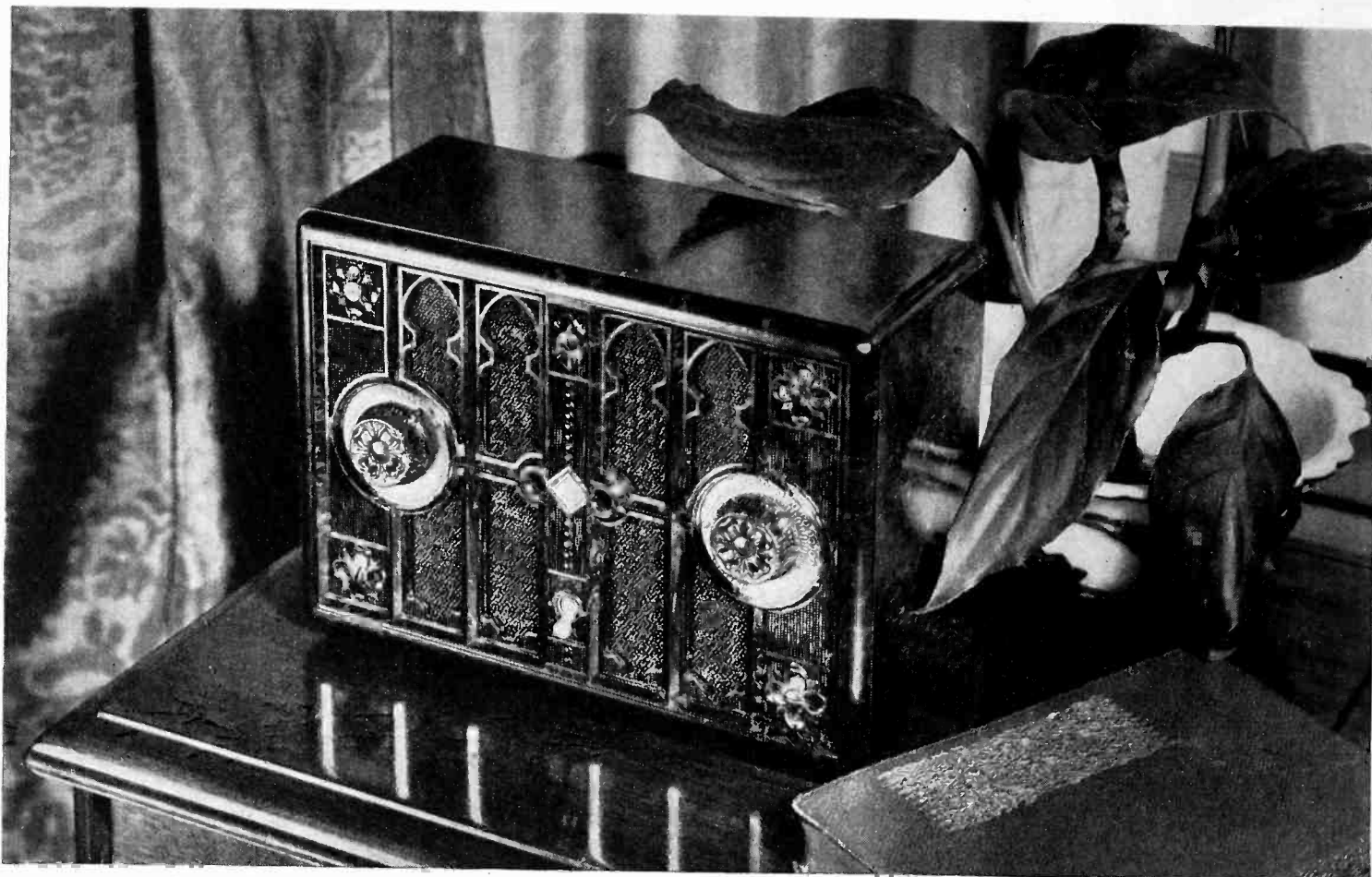

Radio Receiver with Bakelite Molded case, made by International Radio Corp., Ann Arbor, Mich.

THIS midget portable radio receiver, completely housed in a duo-tone Bakelite Molded case, strikes a new note in set design. Provided in a range of lustrous colors it is exceedingly attractive.

The box-like compartment for receiver and speaker, with panel decoration on the front, is produced in a single molding operation, and the back panel in another. These parts with handsome Bakelite Molded control knobs to match, complete the entire case. Accurately formed

and ready for assembly, they require no further finishing operations. The receiver ready for use weighs but five and one half pounds.

For the insulation parts of radio receivers Bakelite Materials are standard practice, and for exterior parts, where attractive appearance is so important, they possess many advantages. Bakelite engineers and laboratories always welcome opportunities to cooperate with manufacturers in advantageously adapting Bakelite Materials to their individ-

ual needs. We will also be glad to mail a copy of our illustrated Booklet 13M, "Bakelite Molded" to anyone interested.



BAKELITE CORPORATION, 247 Park Avenue, New York, N. Y. 43 East Ohio Street, Chicago, Ill.
BAKELITE CORPORATION OF CANADA, LIMITED, 163 Dufferin Street, Toronto, Ontario, Canada

BAKELITE

The registered trade marks shown above distinguish materials manufactured by Bakelite Corporation. Under the capital "B" is the numerical sign for infinity, or unlimited quantity. It symbolizes the infinite number of present and future uses of Bakelite Corporation's products.

T H E M A T E R I A L O F A T H O U S A N D U S E S

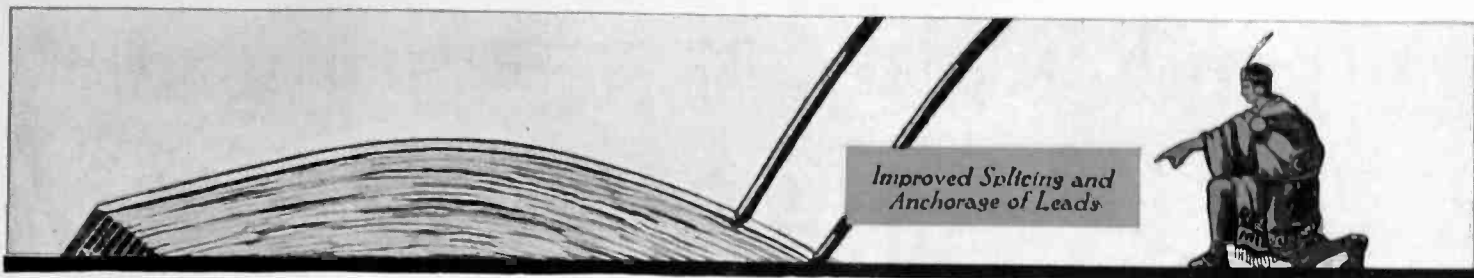

Improved Splicing and Anchorage of Leads

INSIDE YOUR INCA COIL

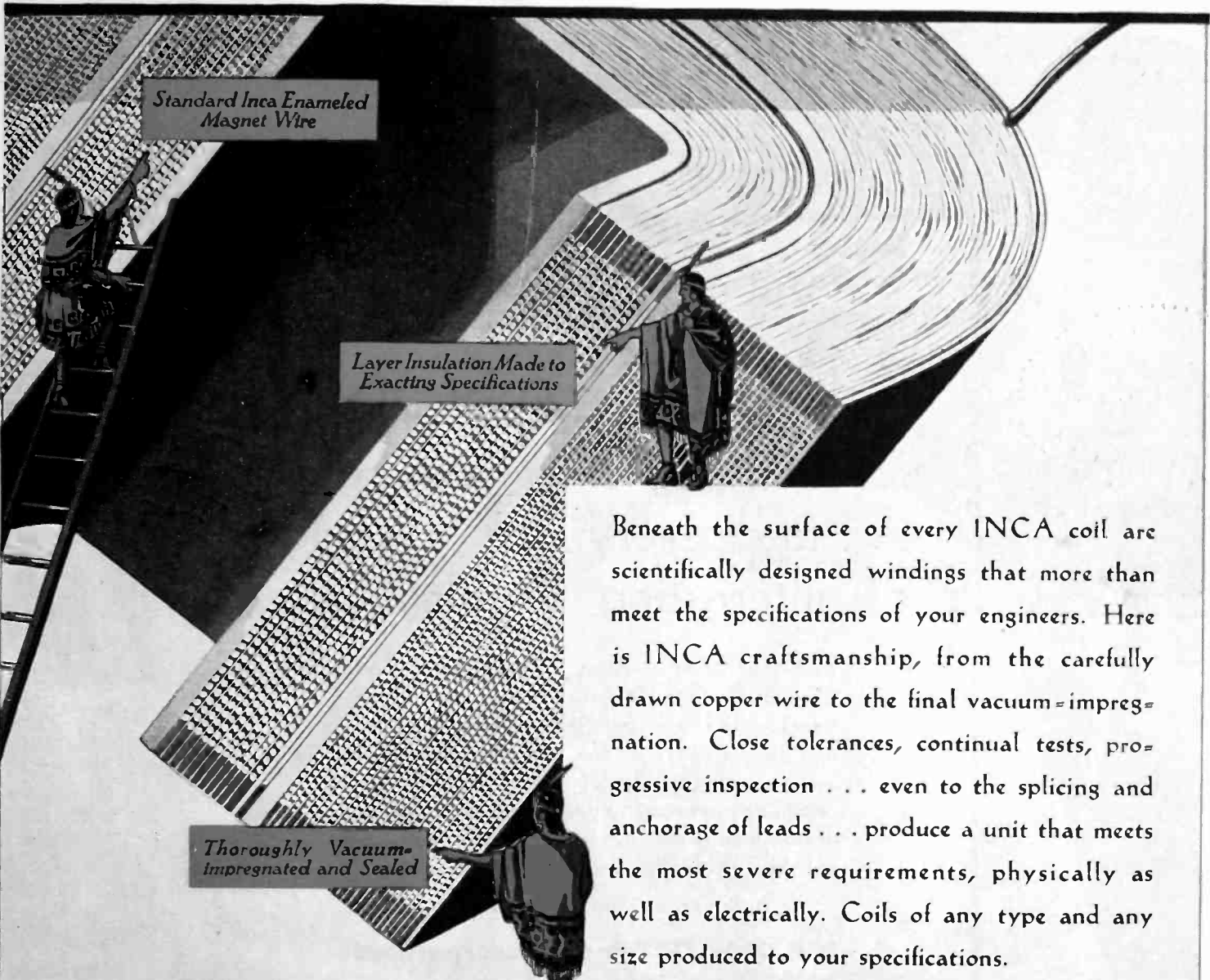

Standard Inca Enameled Magnet Wire

Layer Insulation Made to Exacting Specifications

Thoroughly Vacuum-impregnated and Sealed

Beneath the surface of every INCA coil are scientifically designed windings that more than meet the specifications of your engineers. Here is INCA craftsmanship, from the carefully drawn copper wire to the final vacuum-impregnation. Close tolerances, continual tests, progressive inspection . . . even to the splicing and anchorage of leads . . . produce a unit that meets the most severe requirements, physically as well as electrically. Coils of any type and any size produced to your specifications.



INCA

MANUFACTURING DIVISION

of Phelps-Dodge Copper Products Corp., Fort Wayne, Ind.

Eastern Office:
40 Wall St., New York City

Western Office:
2375 E. 27th St., Los Angeles, Calif.



32 REASONS

for reading this new book
... and every one a page
of interesting usable data

The new Mallory-Yaxley Replacement and General Parts Catalog should be in the hands of all radio engineers. Illustrated throughout and filled from cover to cover with interesting information, this thirty-two page book gives a complete picture of important Mallory-Yaxley developments that have proved to be so valuable and profitable to leaders in the industry.

Write for your copy today!

P. R. MALLORY & CO., Incorporated
INDIANAPOLIS, INDIANA

Reduce Operating Cost Change to GRANGER TUBES » »

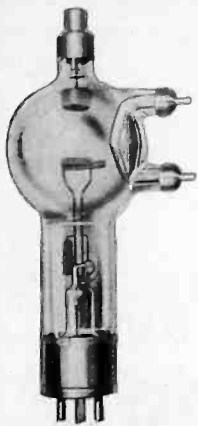

You no longer have to pay high prices for quality tubes. Granger tubes last longer and cost less.

Granger manufactures a complete line of Transmitting Tubes, Power Amplifiers and all types of Mercury Vapor Rectifiers, as well as Photo Electric Cells.

Our Tube Repair Department is equipped to rebuild and service all types of transmitting tubes.

BROADCAST ENGINEERING COMPANY

170 Bruce St., Newark, N. J.

Exclusive Agent for GRANGER MFG. CO.

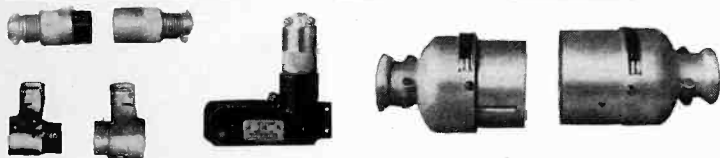

CANNON PLUGS Insure Sound Recording

The leaders in the Sound-Recording field — R C A-Victor — E R P I — Westinghouse — Fox Hearst — Paramount Publix — N B C — Columbia Pictures — R K O — United Artists — Columbia Network — all these and others use CANNON Cable Connectors.

[[There Is A CANNON Plug For Every Sound-Equipment Need.]]

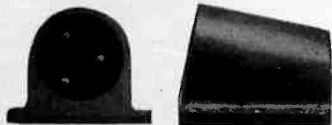

CANNON "Type P-3-48" Plug designed for RCA-Victor Velocity Microphone.

Write for New Catalog—fully illustrated.

CANNON ELECTRIC DEVELOPMENT COMPANY

Manufacturing Engineers

420 West Avenue 33 Los Angeles, Calif.

Eastern Representatives:

New York: A. C. Lopez & Co., 245 5th Avenue
Chicago: Jenkins & Adair, Inc., 3333 Belmont Avenue

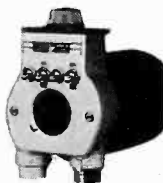
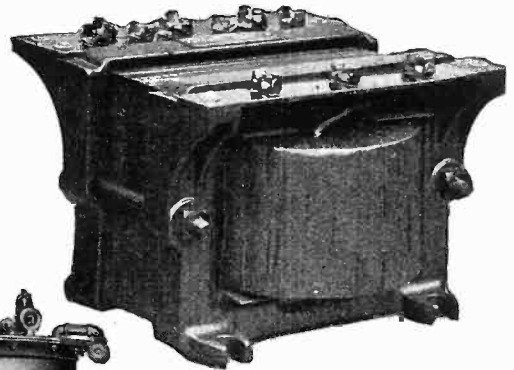
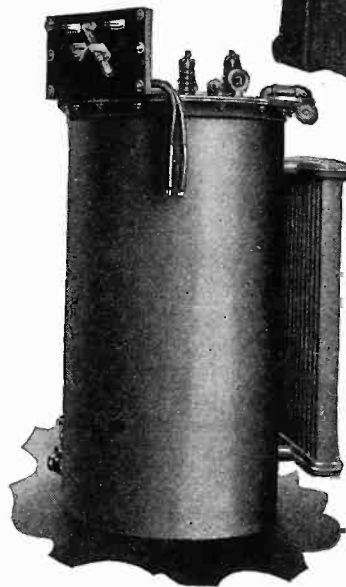

Plate-Supply Transformers

—Built to Meet Every Radio
and Amplifier Application



ABOVE—AmerTran Air-Cooled Plate Transformers are available for all requirements in amplifiers and small radio transmitters; sizes up to 5 kva.; voltages up to 2,000.



LEFT—AmerTran Oil-Immersed Plate Transformers for use in large broadcast transmitters are made in sizes from 5 to 500 kva., and for potentials up to 100,000 volts.

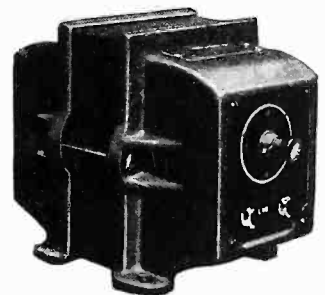

RIGHT—AmerTran Power Transformers for radio sets and amplifiers supply plate and filament voltages. Stock sizes for all standard tubes.

With a background of 30 years' experience in supplying apparatus to meet the special requirements of the radio industry, AmerTran offers more than high-quality transformers—we provide an experienced engineering staff to assist in solving your transformer problems.

Take plate transformers as an example. We have built hundreds of different types for every conceivable application, and we are developing new designs daily. Whether it be for use in a radio set, amplifier, amateur transmitter, or 50 kw. broadcasting station, we would welcome the opportunity of recommending equipment for your needs.

AMERICAN TRANSFORMER COMPANY

Transformer builders for over 31 years

178 EMMET STREET

NEWARK, N. J.



AMERTRAN TRANSFORMERS



NOW!

Exchange
this -



a double offer
a big saving for you!

Here is an announcement of interest to all electrical engineers. A monumental revision of one of the most important and widely used books in the field—offered at a low introductory price—plus an unusual trade-in value if you are an old user of the book. You know the reputation of this book—read on and learn how you can get the new edition, the first in 10 years, at a cost in tune with the times.

Coming Soon!

Revised Enlarged Sixth Edition

STANDARD HANDBOOK FOR ELECTRICAL ENGINEERS

Prepared by a staff of 91 specialists under the editorship of FRANK F. FOWLE, Consulting Engineer
2790 pages, 4½x7, profusely illustrated

1. Special Introductory Price for a limited time only \$6.00

Save \$1.00, about 15%, by sending your order now, at the introductory price of \$6.00. After a limited period the regular price will be \$7.00. Because of the great revision and enlargement of this edition, the Handbook is a bargain at the \$7.00 price—would be even if the book had been issued as first contemplated, in 2 volumes at \$10.00. Consider the value to you of *this* offer, bringing you the NEW Handbook at \$6.00, the same price at which it sold 15 to 20 years ago.

2. An allowance of \$1.00 on your old Standard further lowering the price to \$5.00

Your old Standard Handbook, doubtless well worn, certainly out-dated in part, is still worth something to you. Therefore this additional concession. Exchange your copy of any edition, no matter what its condition, at a value of \$1.00 toward purchase of the new edition. Don't send the old book now. Examine the new edition for 10 days free. At the end of that time, if you want to keep it, send us your old copy and remit only \$5.00 in full payment of the new book.

600 pages larger— almost a new book

This revision of the Handbook took four years to complete. So extensive have been developments in electrical engineering since the fifth edition was published 10 years ago, that the new edition has the aspect of an entirely new book. Every section was thoroughly revised and brought up to date; many parts were entirely rewritten. Whole new sections, much new material throughout the book, were added. Many new contributors were called in to make the book dependable and authoritative from every angle. This edition is 600 pages larger than the previous one, and twice as large as the first. At one stroke this book is placed far in front in point of completeness, modernization and usefulness to you.

10 Days' FREE EXAMINATION

Just check, sign and mail the coupon now. The 6th edition of the Handbook will be sent to you without cost for 10 days' examination as soon as it is off press. Then, after you have had an opportunity to look it over, send us the special introductory price of \$6.00 (or \$5.00 and a copy of an earlier edition of the Handbook), or return the book. But act promptly as this offer is for a limited time only. Be sure to get this saving; send the coupon now.

Send
this
Coupon
Now!

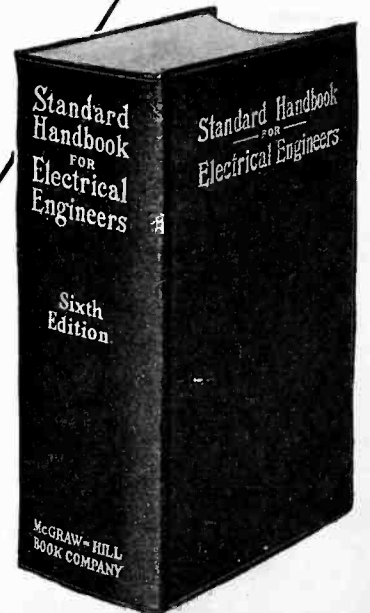

for
this!

FREE EXAMINATION COUPON

McGRAW-HILL BOOK COMPANY, INC.
330 W. 42nd St., New York

Send me the new 6th edition, Standard Handbook for Electrical Engineers, postpaid, for 10 days' free examination. Within 10 days after receipt I will either return the book or:

- Send you the special introductory price of \$6.00.
- Send you \$5.00 and my copy of an earlier edition of the Standard Handbook.

Name

Address

City and State

Position

Company L. 12-32

Books Sent On Approval To U. S. and Canada Only.

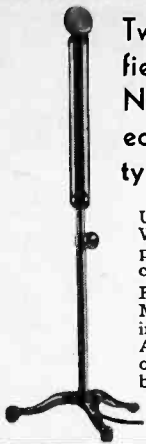

Two stage amplifier. 864 tubes. New acoustic equalizer. Floor type list \$125

REMLER CONDENSER MICROPHONE

Used and endorsed by radio stations throughout the country. WFAS says: "Beautiful visually and from engineering standpoint." Harington, engineer, says: "Unbelievable that you can sell such a high-grade product at so low a price."

Features: Precision machined sensitive head free from noise. Moisture proof. Special alloy diaphragm. Shock proof; mica insulated. Non-resonant grill. Copper shielded housing. Audio filters eliminate oscillation. 50-200 or 200-500 ohm output. Essentially flat response 40 to 10,000 c.p.s. Statuary bronze finish.

Send for folder showing Remler Company, Ltd. four types with prices. 2101 Bryant St., San Francisco

REMLER—THE RADIO FIRM AS OLD AS RADIO



The New SHALLCROSS General Purpose Meter No. 610

provides facilities for a wide range of electrical measurements not usually possible in one instrument. Employing a No. 610 Shallcross Resistor Kit and the Weston Model 301 Universal Meter, this combination meter measures
4 D.C. Volt. Ranges 4 A.C. Volt. Ranges
4 D.C. Cur. Ranges
Resistance Measurements of 1 ohm to 3 megohms
Inductance measurements, 1 to 10,000 henrys
Capacity measurements, .001 to 10 mfd.
Output Meter
Send 6c. in stamps for Bulletin 152-K, describing this modern useful instrument.

SHALLCROSS MFG. CO.
Electrical Specialties 700 Parker Ave.
Collingdale, Pa. (near Philadelphia)

GEN-ERAL COILS

Reg. U. S. Pat.

For FIVE TUBE SUPER

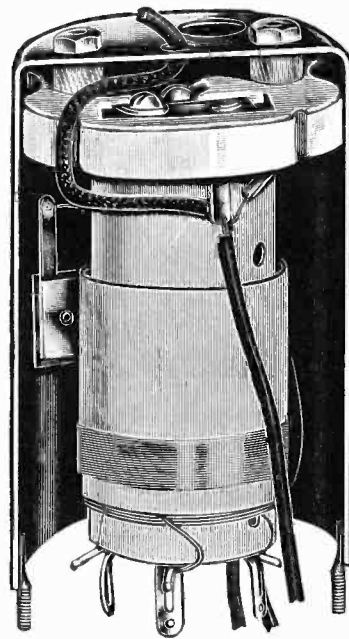

CX200
D.V.M.
Comp.

Complete Diagram of Circuit
on Request.

GENERAL MANUFACTURING CO.

8068 South Chicago Ave.

Chicago

Cable: GENRAL U. S. A.

Illinois

*A Message to
Manufacturers:*

Standing Still Is a Rapid way of Going Backward These Days

It takes only a mild scare for some manufacturers to stop their advertising. "Oh, well", they say, "we have been advertising right along so we can coast along for a while on the momentum that our advertising has given us". Slash! goes their advertising campaign. Crash! goes the morale of their sales force. Down! go volume and profits.

Fallacious, disastrous reasoning! For momentum is the gradual process of coming to a dead stop. The manufacturer who relies on the momentum of past advertising surely must some day get steam up all over again. And that takes time and money.

ELECTRONICS
—A McGraw-Hill Publication

EBY Parts for Better Sets

Positive—Efficient

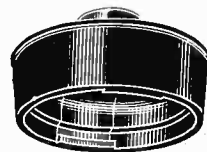

Socket Cable Connector
Disassembled View

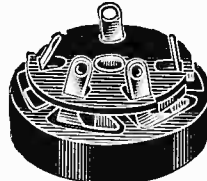

Socket Cable Connector
Assembled View

The Eby Moulded Female Connector consists of a moulded cap and a socket assembly. The two fit together by means of a bayonet arrangement which permits quick and positive assembly and disassembly.

Also available with a longer moulded cap and a larger hole in end which makes it especially adaptable for use in auto sets requiring heavy, armored cable.

Furnished for 4-5-6-7 prongs.
Your inquiries are solicited.

Laminated Sockets

Eby Laminated Sockets represent the last word in the design of units intended to provide a perfect, long-lasting, efficient, low resistance contact between circuit wiring and tube in plug connector prongs.

Write for full particulars.



The H. H. EBY Mfg. Co., Inc.

Philadelphia

Los Angeles

Chicago

New York

“The dead take
to their graves, in their
clutched fingers, only that
which they have given away”



THIS is your chance to do more good with the money you give to others than was perhaps ever before possible in the history of this country.

First, because the *need* is greater than ever before. Second, because more of every dollar you give will go to provide your fellow human beings with food, shelter, medical help—the bare necessities of living.

The Welfare and Relief Mobilization for 1932 is a cooperative national program to reenforce local fund-raising for human welfare and relief needs. No national fund is being raised. Each community is making provision for its own people. Each community will have full control of the money it obtains.

Read again the great words attributed to Rousseau which are printed at the top of this page. Then *give* through your established welfare and relief organization, through your community chest, or through your local emergency relief committee.

Newton D. Baker

NEWTON D. BAKER, CHAIRMAN
NATIONAL CITIZENS' COMMITTEE

WELFARE AND RELIEF MOBILIZATION, 1932

PROFESSIONAL SERVICES

Design
Testing

Research
Measurement

Consulting
Development

Patents
Acoustics

AMY, ACEVES & KING, Inc.

Consulting Engineers
Inventors of The Multicoupler Antenna System for apartment houses.
Specializing in Radio Design—Test—Development.
11 W. 42nd St., New York City
Phone: Longacre 5-6622

ALLEN B. DuMONT LABORATORIES

CATHODE RAY TUBES
AND ASSOCIATED APPARATUS
Technical data on request.
Upper Montclair, N. J.

ELECTRO—ACOUSTICAL ENG. CO. OF AMERICA

Acoustical Correction—Soundproofing
Reverberation Control Systems
Electrical Testing
Research Development
Offices and Laboratories
1609 Vine St., Philadelphia, Pa.

The Real Value

of placing your unusual problem in the hands of a competent consultant eliminates the elements of chance and uncertainty from the problem and provides real facts upon which to base decisions.

ELECTRICAL TESTING LABORATORIES

Characteristics and
Life Tests of Vacuum Tubes
Tests of photocells, glow lamps, crater lamps.
Tests of electronic and optical devices.
80th Street and East End Avenue
New York, N. Y.
Phone: Butterfield 8-2600.

JENKINS & ADAIR, INC.

Engineers
Designers, developers, and manufacturers of accessories and essentials for recording, broadcasting and testing at sound frequencies.
3333 Belmont Avenue, Chicago, U. S. A.
Cable Address: Jenkadair Telephone: Keystone 2130

Lancaster, Allwine & Rommel

PATENTS—TRADE MARKS
All cases submitted given personal attention by members of the firm.
Information and booklet free.
Patent Offices & Federal Court Practice
Patent Law Offices
Suite 431 at 815 15th Street, N. W.,
Washington, D. C.

RALPH H. LANGLEY, E. E.

Licensed Professional Engineer Fellow I.R.E.
Twenty years' experience in the Development, Design, Production of Radio Transmitters and Receivers and in Radio Patents and Inventions.
Harley 7-0398
165 Broadway, New York.

SEARCHLIGHT SECTION

POSITIONS WANTED

M.S. in Physics, experienced 16 mm. sound-on-film, television and related fields, desires development opportunity in New York. Age 30. PW-41. Electronics, 330 West 42d St., New York City.

RADIO ENGINEER with ten years' radio experience, including manufacturing and laboratory work, also considerable television and ultra-short wave transmission, wishes position in engineering line. PW-42. Electronics, 330 West 42d Street, New York.

RADIO and vacuum tube engineer, long experience with all kinds of vacuum devices, including neon and television and other lamps, would like job requiring originality, inventive ability, and sound technical knowledge. At present employed. PW-43. Electronics, 330 West 42d St., New York City.

Men Wanted

We require a man in each community, FULL or SPARE time, as local representative. The work is dignified, permanent, and pays well. You simply recommend and call to the attention of business men and workers of all kinds or to fellow employees, the most complete line of business and technical books ever published. They find in our books the ready reference knowledge that gives them quick and valuable assistance in their daily work, and helps increase daily earnings or profits promptly and effectively. You can make \$1 to \$3 an hour easily showing our lists. No experience required. Complete equipment.

Write Tom Crawford, Dept. E.

McGRAW-HILL BOOK CO.
330 West 42d Street, New York City

electron tube equipment

New—Reconditioned and "As Is"

Used equipment available—Stem, Sealing, Exhaust, Flare, Basing, and Bead Machines, Also Air Blowers, Gas Boosters, Spot Welders, Aspirators, Vacuum Pumps and etc.
Buy Direct from the Manufacturer—Be Assured of Full Value—Advise Us of Your Requirements.

EISLER ELECTRIC CORPORATION

Manufacturers of Electron Tube, Neon Sign and Incandescent Lamp Equipment
756 So. 13th St., Newark, N. J.

High Grade New and Used ELECTRON TUBE EQUIPMENT

Vacuum Pumps, Stem Machines, Sealing Machines, Spot Welders, Air Blowers, Gas Boosters, Aspirators, Flare Machines, Basing Machines, Stem Benders, Transformers, Rheostats, Grid Winders, etc.

Write for Bulletin Showing Savings
From 20% to 80%

KAHLE ENGINEERING CO.

Specialists in Equipment and Methods for the Manufacture of Neon Tubes, Radio Tubes, Incandescent Lamps, Photo Cells, X-ray Tubes, etc.
300 Manhattan Ave., Union City, N. J.

Mr. Broadcaster:

You do not have to use a Microscope when searching for overhead items that may be cut without impairing the General Efficiency of Your Station.

Our Reconditioning Service on Transmitting Tubes will offer you a ready means of effecting a cut in your Tube Overhead.

Our 1000 hours Operating Guarantee, coupled with our Guarantee of Safe Delivery, doubly insures your Savings when using our Service.

There is no risk in trying our Service, for if you do not like our work, and return the tube at once, we will Refund Your Money.

Decide Now!

National Radio Tube Co.

3420 Eighteenth Street
San Francisco, California



Rely on Astronomical Time for Your Standard of Frequency

This equipment supplies frequencies over the entire communication spectrum . . . Each is checked against time signals from the U. S. Naval Observatory.

HUNDREDS of standard frequencies can be obtained from the Class C-21-H Standard-Frequency Assembly, covering a range of from one cycle per second to several megacycles, and each frequency is known to better than one part in a million. A synchronous clock, driven from the standard-frequency oscillator, is compared with radio time signals to determine the frequency.

Rugged construction, high accuracy, and flexibility make this assembly suitable for both laboratory and industrial installations. Many Class C-21-H Standard-Frequency Assemblies are now in operation in all parts of the world. They are operating under widely differing climatic conditions and their uses vary from the precise measurement of time intervals to the accurate monitoring of radio transmitters.

Among the users of this equipment are the U. S. Army, British Royal Air Force, Canadian Department of National Defense, Canadian Department of Marine, the governments of Japan, Russia, and the Netherlands, Mackay Radio and Telegraph Company, Heintz and Kaufman, Globe Wireless Limited, Philadelphia Storage Battery Company (Philco), Premier Crystal Laboratories, Harvard University, and the University of Texas.

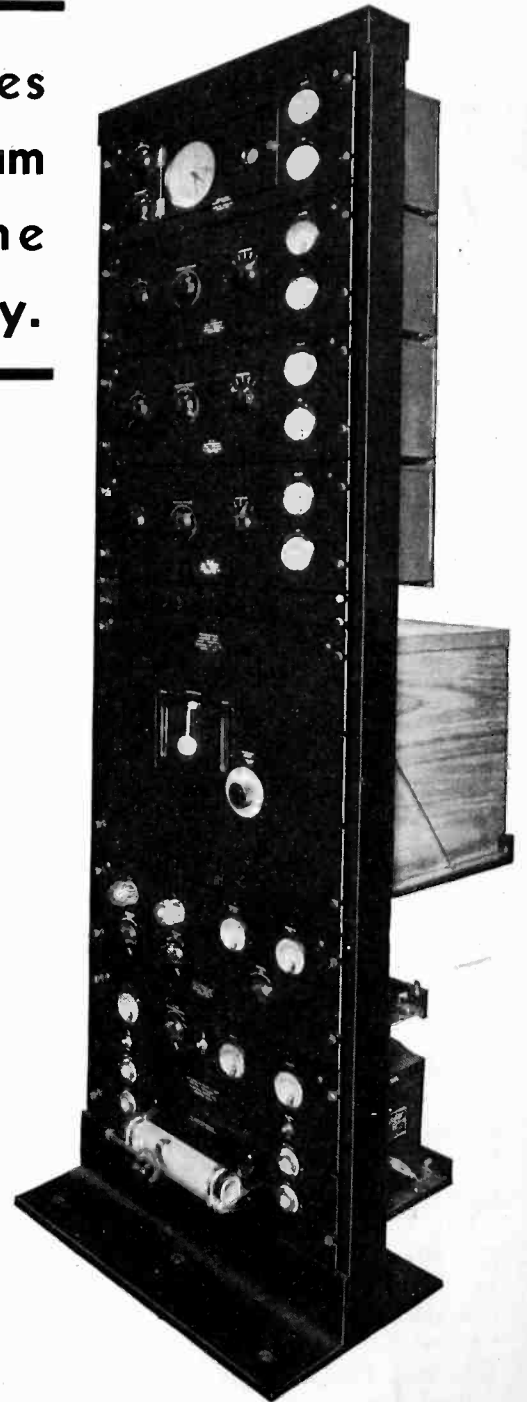

For further information about the Class C-21-H Standard-Frequency Assembly, address the General Radio Company, Cambridge A, Massachusetts.

GENERAL RADIO Co.

INSTRUMENTS OF PRECISION AND DEPENDABILITY